

RESEARCH

# The syntax of sign language agreement: Common ingredients, but unusual recipe

Roland Pfau<sup>1</sup>, Martin Salzmann<sup>2</sup> and Markus Steinbach<sup>3</sup>

<sup>1</sup> Universiteit van Amsterdam, Spuistraat 134, 1012 VT Amsterdam, NL

<sup>2</sup> Universität Leipzig, Beethovenstr. 15, 04107 Leipzig, DE

<sup>3</sup> Universität Göttingen, Käte-Hamburger-Weg 23, 37073 Göttingen, DE

Corresponding author: Markus Steinbach (msteinb@gwdg.de)

---

The sign language phenomenon that some scholars refer to as “agreement” has triggered controversial discussions among sign language linguists. Crucially, it has been argued to display properties that are at odds with the notion of agreement in spoken languages. A thorough theoretical investigation of the phenomenon may thus add to our understanding of the nature and limits of agreement in natural language. Previous analyses of the phenomenon can be divided into three groups: (i) gesture-based non-syntactic analyses, (ii) hybrid solutions combining syntactic and semantic agreement, and (iii) syntactic accounts under which agreement markers are reanalyzed as clitics. As opposed to these accounts, we argue in this paper that sign language agreement does represent an instance of agreement proper, as familiar from spoken language, that is fully governed by syntactic principles. We propose an explicit formal analysis couched within the Minimalist Program that is modality-independent and only involves mechanisms that have been independently proposed for the analysis of agreement in spoken language. Our proposal is able to capture the (apparent) peculiarities of sign language agreement such as the distinction of verb types (only some verbs show agreement), the behavior of backwards verbs (verbs displaying agreement reversal), and the distribution of the agreement auxiliary. However, we suggest that the combination of mechanisms is modality-specific, that is, agreement in sign language, and in German Sign Language in particular, involves modality-independent ingredients, but uses a modality-specific recipe which calls for a (somewhat) unusual combination of independently motivated mechanisms.

---

**Keywords:** agreement; auxiliaries; differential object marking; ergativity; German Sign Language; Minimalist Program

---

*In memoriam Irit Meir (1957–2018)*

## 1 Introduction

In many languages, the particular form of a verb (the agreement target) depends on formal or semantic properties (of one) of its arguments (the agreement controller). Steele (1978: 610) defines agreement as follows: “The term agreement commonly refers to some systematic covariance between a semantic or formal property of one element and a formal property of another.” (cf. also Moravcsik 1978; Lehmann 1982; 1988; Corbett 2006). Verb agreement in sign language (SL) has intrigued scholars for a long time because, on the one hand, the form of the inflected verb depends on properties of two of its arguments, i.e. we observe a systematic covariance between a formal property of the arguments (referential loci) and a formal property of the verb (path movement and hand orientation). On the other hand, agreement in SLs seems to display properties clearly distinct from spoken language agreement (see e.g. Padden 1983[1988]; Janis 1995; Bahan 1996; Keller 1998;

Meir 1998; 2002; Mathur 2000; Rathmann & Mathur 2002; Mathur & Rathmann 2012; Lillo-Martin & Meier 2011). What many sign linguists consider an instantiation of agreement involves the spatial modification of verbal signs in the signing space. A typologically striking feature of this process is that, across SLs, not all verbs partake in it in the same way. In addition, various modality-specific properties have been described. We discuss these specific properties of SL agreement in more detail in the next Section.

Simplifying somewhat, three different types of approaches to the phenomenon of spatial modification have been offered in the literature. The first account within the framework of cognitive grammar argues that the SL phenomenon commonly described as agreement actually involves a fusion of morphological and (deictic) gestural elements; consequently, even the applicability of the term “agreement” is debated. Things are very different in the second approach at the interface between syntax and semantics. According to this influential account, SL agreement is hybrid in the sense that thematic roles and grammatical functions determine the surface form of the verb. A third approach offers a purely syntactic analysis and argues that agreement markers are actually clitics. This means, however, that agreement in SLs is not syntactic agreement in the strict sense. In Section 3, these three approaches will be discussed in more detail.

In the present paper, we argue for a fourth perspective – and one that is less prominently represented in the literature – by adopting the strong hypothesis that all instances of SL agreement are syntactic in nature. We show that all three approaches – the gestural, the hybrid, and the clitic account – are faced with empirical and theoretical problems, and we demonstrate that a consistently syntactic implementation is not only possible but also offers a number of significant advantages. It is important to note that our analysis is based on data from German Sign Language (*Deutsche Gebärdensprache* – DGS). SLs have been shown to typologically differ from each other in various grammatical domains (Perniss et al. 2007; Zeshan 2008; de Vos & Pfau 2015), and it can therefore not be taken for granted that our analysis will be applicable to all SLs without modifications. Yet, given that “the spatial resources available to SLs yield relative uniformity in the pronominal and agreement systems of sign languages” (Meier 2012: 588), we do assume that our account can be applied to other SLs, at least those that use space in a similar way, and to SLs that develop similar morphosyntactic means (such as, for instance, agreement auxiliaries) to express agreement. We come back to the issue of typological variation at the end of this paper in Section 5.<sup>1</sup> Note that our analysis is not only syntactic but also formally explicit and cast within a specific framework (the Minimalist Program).<sup>2</sup> This strikes us as important because the success (as well as the possible pitfalls) of a (syntactic) analysis only become visible once one is forced to adhere to a certain set of (independently motivated) assumptions.

This paper is organized as follows: In Section 2, we set the stage for the following discussion by sketching the basics of SL agreement. In Section 3, we then turn to previous gestural and grammatical accounts, namely, Liddell’s mental space approach, Meir’s and Bos’ thematic accounts, and Nevins’ clitic analysis, and we show that these approaches are faced with a number of serious conceptual and empirical problems. Section 4 introduces our own analysis that is based on a standard Minimalist system involving the operation

<sup>1</sup> Some of the so-called “village” or “rural” SLs, that is, SLs that emerged in small, and sometimes fairly isolated, communities with an unusually high number of deaf inhabitants, appear to be exceptional with respect to the expression of agreement; see Padden et al. (2010); de Vos & Pfau (2015); and Section 5 for discussion.

<sup>2</sup> We have chosen the Minimalist Program since it is the framework within which most work on agreement has been carried out to date, which thus facilitates contextualization of our proposal, but of course, an analysis within a different framework is conceivable as well.

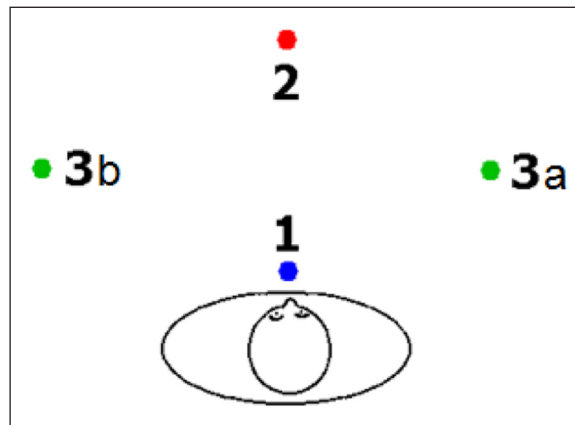

**Figure 1:** Localization of referents in the signing space; the signer (locus 1) and the interlocutor (locus 2) are always present, while third person referents (locus 3) can be present or non-present.

Agree that copies features from controllers onto targets and derives the different instantiations of agreement in DGS by means of differences in verb movement and featural content of functional heads. Crucially, our proposal is strictly syntactic and only employs mechanisms that have been independently motivated based on typologically diverse spoken languages. At the end of Section 4, we address three additional aspects relevant for the analysis of SL agreement: (i) combinations of agreement verbs and agreement auxiliaries, (ii) optionality, and (iii) differential argument encoding. In Section 5, we show that SL agreement involves a special combination of independently established mechanisms. This special recipe is motivated by the gestural and spatial properties of SLs such as the thematic origin of agreement, the use of the three-dimensional signing space, and the simultaneous realization of grammatical features. Section 6 concludes the paper.

## 2 Sign language agreement: The basic facts

In most SLs studied to date, discourse referents can be linked to referential loci (so-called R-loci) in the signing space (Figure 1). These loci are either actual locations of present referents or arbitrary locations that are assigned to non-present referents by means of a pointing sign (which is glossed as INDEX). Note that “arbitrary” should be understood as semantically arbitrary; it should not be taken to imply that the choice of locations could not be subject to certain (language-specific) grammatical and pragmatic principles (see Cormier et al. 2015; Steinbach & Onea 2016).<sup>3</sup>

For illustration of the localization mechanism, consider the DGS examples in (1). In (1a), the non-present referent MOTHER is localized at location 3a (see Figure 1) by means of INDEX<sub>3a</sub>, a pointing sign (index finger extended) targeting a locus in the front right

<sup>3</sup> Assigning a locus to a new discourse referent by means of a pointing sign, as in (1a), is the most explicit overt strategy for locus assignment. Besides this, sign languages, including DGS, may employ more covert assignment strategies. It is, for instance, possible to assign a locus by means of the agreement verb itself (see Costello 2015 for Spanish SL). Alternatively, signers may use non-manual strategies such as body leans or eye-gaze towards a particular R-locus or a covert “right-left default pattern” (Lillo-Martin 1986; Winston 1996; Steinbach & Onea 2016).

Wienholz et al. (submitted) conducted an ERP study that tested the interpretation of pronouns in DGS in contexts without overt localization of previously introduced discourse referents. The study provides empirical evidence for the claim that signers use default patterns to assign distinct R-loci to discourse referents in the absence of overt manual or non-manual markers. In their study, right-handed signers assign the first discourse referent by default to the ipsilateral (= front-right) area and the second one to the contralateral (= front-left) area of the signing space, that is, they exploit the geometrical properties of the signing space in a systematic way to establish an optimal contrast between the R-loci linked to the first two discourse referents.

(ipsilateral) area of the signing space. Crucially, this location is arbitrary, that is, it does not reflect a spatial configuration in the real world (for instance, the mother living in a town that is situated in the direction of the vector projected from the fingertip). Subsequently, the agreement verb VISIT moves from locus 3a, associated with the subject, towards locus 1, associated with the object, thereby expressing agreement with a third-person subject and a first-person object. The video stills in Figure 2 illustrate the beginning and end point of the verb's movement.<sup>4,5</sup>

- (1)
- a. YESTERDAY POSS<sub>1</sub> MOTHER INDEX<sub>3a 3a</sub> VISIT<sub>1</sub>  
'Yesterday my mother visited me.'
  - b. POSS<sub>1</sub> BIRTHDAY PARTY, INDEX<sub>1 2</sub> INVITE<sub>1</sub>  
'As for my birthday party, I will invite you.'
  - c. INDEX<sub>1</sub> NEW TEACHER LIKE  
'I like the new teacher.'

Yet, in a subset of agreement verbs, the so-called “backwards verbs” (BAV) (Padden 1983[1988]; Brentari 1988), movement proceeds in the opposite direction, that is, from the position of the object towards the position of the subject, despite the fact that in both types of verbs, the agent is the syntactic subject (for evidence, see Section 4.3). This is illustrated in (1b) by means of the DGS verb INVITE. Note that in both (1a) and (1b), the subscript ‘1’ follows the verb, which indicates that the end point of the movement coincides with locus 1; yet, locus 1 is associated with the object in (1a) but with the subject in (1b).



**Figure 2:** Video stills showing the beginning and end point of the movement of the verb VISIT in example (1a): Movement starts at the front right side of the signing space (locus 3a, introduced for non-present referent MOTHER) and ends close to the signer's body (locus 1).

<sup>4</sup> Two reviewers enquired about our methodology. It is important to note that the focus of the present study is theoretical, not empirical in nature. No DGS examples have been elicited specifically for this study. Rather, the examples in (1)–(3) are based on published examples, and their grammaticality is uncontroversial. Still, they have been double-checked with two native signers. Things are slightly different for the examples in (19) below. The grammaticality of (19a) has long been established in the literature (e.g. Pfau 2002), but examples like (19b) have not previously been discussed in the literature. As before, we checked the acceptability of these examples with two native signers.

<sup>5</sup> Sign language examples are given in English SMALL CAPS, which represent (approximations of) the meaning of the signs. Subscript numbers refer to locations in the signing space (as shown in Figure 1) which are employed for agreement and pronominalization. POSS is a possessive pronoun, which is signed with a flat hand (B-hand) in DGS. A line above the glosses indicates the scope of non-manual markers, in particular, a side-to-side headshake signaling negation.

In addition, all SLs for which such spatial modulations have been described also feature a substantial number of verbs, the so-called “plain verbs”, in which the beginning and end point of the movement component cannot be modified. An example of a plain verb in DGS is the verb LIKE. This verb is lexically specified for contact with the signer’s chest, that is, it is a so-called body-anchored verb. Consequently, in (1c), LIKE cannot be spatially modified to move between the relevant locations 1 and 3a.

Interestingly, some SLs have developed means to express agreement in the context of plain verbs, namely dedicated manual markers, generally referred to as agreement auxiliaries, which express the agreement relation whenever the main verb is not capable of doing so (see Steinbach & Pfau 2007 and Sapountzaki 2012 for cross-linguistic surveys). DGS is one of these SLs, as it employs an auxiliary glossed as PAM (Person Agreement Marker; Rathmann 2000; 2003). Actually, example (1c) would usually be signed as shown in (2). As can be seen in Figure 3, PAM appears clause-finally in the DGS variety we investigated<sup>6</sup> and moves from locus 1 to locus 3a, thus marking the subject and object of the lexical verb.<sup>7,8</sup>

- (2) INDEX<sub>1</sub> NEW TEACHER LIKE <sub>1</sub>PAM<sub>3a</sub>  
 ‘I like the new teacher.’

Importantly, agreement by path movement is found with both transitive and ditransitive verbs. With the latter, it always targets the goal/indirect object rather than the theme.

In addition to agreement by path movement, agreement verbs also agree by means of orientation, viz., the orientation of the hand changes, depending on the object. In the following example, there is not only path movement from subject to object; additionally, the fingertips are oriented towards the object, thus also expressing further agreement with



**Figure 3:** Video stills showing the beginning and end point of the movement of the agreement auxiliary PAM in example (2): Movement starts close to the signer’s body (locus 1) and ends at the front right side of the signing space (locus 3a, introduced for the non-present referent TEACHER).

<sup>6</sup> A first corpus study on the distribution of PAM has been conducted by Macht (2016). The statistical evaluation of data taken from the Hamburg DGS corpus shows that in most varieties, PAM occurs in sentence-final position as argued in Steinbach & Pfau (2007). Only in southern varieties of DGS does PAM preferably occur in pre-verbal position (see also Macht & Steinbach, in press). In addition, PAM productively combines with first and non-first arguments.

<sup>7</sup> Note that from a typological perspective, these auxiliaries are atypical in the sense that – unlike most auxiliaries in spoken languages – agreement auxiliaries in SLs are not used to encode tense, aspect, or modality (see Pfau & Steinbach 2007 for details).

<sup>8</sup> For the combination of PAM with agreement verbs, see Section 4.5.1.



the object (under the reverse predication, i.e. “My daughter influences me”, the fingertips would be oriented towards the signer).

- (3) INDEX<sub>1</sub> MY DAUGHTER INDEX<sub>3a 1</sub> INFLUENCE<sub>3a</sub>  
 ‘I influence my daughter.’

Crucially, with BAVs, agreement by orientation also targets the object rather than the subject. They thus do not show any reversal w.r.t. hand orientation. Like agreement by path movement, agreement by orientation is found with both transitive and ditransitive verbs. With the latter, it again targets the goal/indirect object rather than the theme. Agreement with intransitive verbs is only rarely attested; see, for instance, Costello (2015) for agreement marked on the verb *DIE* in Spanish SL (LSE).<sup>9</sup>

A final modality-specific property of SL agreement to be mentioned here is the primacy of object agreement over subject agreement. There are different aspects of this primacy: First, according to much of the literature, object agreement is obligatory, while subject agreement is optional; see, e.g., Meier (1982); Padden (1983[1988]); and Lillo-Martin & Meier (2011) on American SL (ASL); Morgan et al. (2006) on British SL (BSL); and de Quadros & Lillo-Martin (2007) on Brazilian SL (Libras). Second, there are some agreement verbs, such as ASL *ANSWER*, on which only object agreement can be marked. In a similar vein, Schuit (2013) observes that in Inuit SL verbs are only ever modified for their object, but never for their subject. By contrast, agreement verbs that only mark subject agreement are not attested. The primacy of object agreement is a modality-specific property of SL agreement since in spoken languages, subject agreement is generally much more common (but see Siewierska 2013 for exceptions). We will argue in Section 4.3 that the omission of the subject agreement marker can be analyzed as an instance of default agreement. In a recent corpus-based study, Fenlon et al. (2018) have found neither subject nor object agreement to be obligatory in BSL. Agreement is favored if local person arguments (first and second person) and animate objects are involved (cf. also Murmann et al. 2013 and footnote 42 below on the influence of animacy on agreement in DGS). Further factors that favor agreement are coreference with a null argument in the preceding clause and role shift (constructed action). There is a reflex of object primacy in that in Fenlon et al.’s corpus objects are more frequently marked on the verb than subjects.<sup>10</sup> We return to optionality and its implications for our approach in Section 4.5.2.

### 3 Sign language agreement: Perspectives and challenges

Having introduced the basics of SL agreement, we now turn to previous accounts of the phenomenon. In the following discussion, we address three major accounts of SL agreement. We begin with the gestural account first proposed by Liddell (Section 3.1) and then turn to two hybrid approaches by Meir and Bos that combine thematic and syntactic agreement (Section 3.2) before we address Nevins’ clitic analysis that is purely syntactic (Section 3.3). In all three subsections, we highlight empirical and conceptual challenges that these accounts are faced with.

<sup>9</sup> The fact that intransitive verbs normally do not agree can be related to the diachronic origin of SL agreement, viz., the gestural expression of transfer (see next section). Given that agreement is becoming increasingly grammaticalized (and, as we will argue below, dissociated from thematic agreement as argued in Steinbach 2011), we would expect agreement to be instantiated with intransitive verbs as well over time (cf. Section 5 for further discussion).

<sup>10</sup> We are grateful to one of the reviewers for drawing our attention to this study. The interpretation of the figures is complicated by so-called “congruent signs” for which it is impossible to tell whether the sign is modified because the locations associated with the arguments in question happen to be identical to the locations characterizing the citation form of the verb. Once the congruent signs are taken into account, the frequency of subject and object agreement is identical, viz. 65%.

### 3.1 Gestural accounts

Liddell (1995) was the first to propose that the spatial loci that appear on certain verbs and pronouns and that have been characterized as instantiations of agreement, are actually gestural in nature, fully on a par with the loci that characterize certain co-speech gestures, such as, for instance, deictic gestures (Kita 2003; Kendon 2004). He therefore refers to these verbs as “indicating verbs” and suggests that their directionality is controlled by the (real or imagined) location of the referents, and not by a grammatical feature that is copied from a controller. In other words: The spatial modification of verbs works as a reference-tracking device through the fusion of a lexical sign with a pointing gesture.<sup>11</sup>

#### 3.1.1 Mental spaces and indicating verbs

In order to account for the surface forms of indicating verbs, Liddell applies Fauconnier’s (1985; 1997) theory of mental spaces. When a discourse referent is present, the signer makes use of *real space*, that is, of his “current conceptualization of the immediate environment based on sensory input” (Liddell 2003: 82) – in this case, the verb will point towards the actual location of this referent. In cases in which a signer directs a sign towards a locus associated with a non-present referent, he makes use of a real-space blend, in which mental space elements are mapped onto real space, a “cognitive act [that] involves conceptualizing things as something other than what they are” (Liddell 2003: 175). This type of space is referred to as *surrogate space*. According to this proposal, directing the verb VISIT in (1a) towards a locus associated with my (non-present) mother, is like directing a pointing gesture towards an empty chair while uttering ‘He recently argued against this claim’ in order to refer to a (non-present) person who usually occupies this chair.

Important motivation for Liddell’s gestural approach comes from the so-called “listability problem”. Crucially, the possibilities for directing verbs in space are indefinite, as there is an infinite number of loci. That is, what we labeled as “3a” and “3b” in Figure 1 are not specific loci but rather areas from which a specific locus is selected and assigned to a referent within a stretch of discourse. This, in turn, implies that there is also an indefinite number of agreement morphemes, and these morphemes can thus not be listed in the lexicon – a typologically highly unusual state of affairs. Unlike what is normally the case in spoken languages, agreement in SLs would thus register non-stable/transient properties.<sup>12</sup>

Related to the listability issue is the issue of canonicity. Based on agreement patterns in spoken languages, Corbett (2006) offers a set of 20 criteria that describe different options for agreement systems and determines for each of them a canonical value in accordance with general principles that are taken to characterize canonical agreement. Crucially, the most canonical system is one that best conforms to the general principles and not necessarily the system that is most common among the world’s languages. On the one hand, it has been pointed out that the system of spatial modulation present in SLs is non-canonical according to Corbett’s criteria (Corbett 2006: 264, fn. 1), and this non-canonicity is taken as a further argument in favor of a gestural account (see also Cysouw 2011 and Schembri et al. 2018). On the other hand, it has been argued that canonicity is not a crucial argument against a (grammatical) agreement analysis (Quer 2011; 2017). In the next section, we discuss the arguments against an (grammatical) agreement analysis in more detail.

<sup>11</sup> Crucially, this line of reasoning should not be taken to imply that Liddell considers SLs gestural communication systems. He does assume that SLs are fully-fledged natural languages with complex grammars (see Chapter 2 in Liddell 2003). It is only the pervasive use of spatial resources that is taken to fall within the domain of gesture.

<sup>12</sup> The morpheme/locus marking first person is an exception. It has thus been suggested that SLs distinguish first and non-first person, rather than first, second, and third person, in their pronominal and agreement system (see Meier 1990 and Lillo-Martin & Meier 2011 for further arguments).

### 3.1.2 Listability, canonicity, and variation

Since the publication of Liddell's seminal (2003) monograph, several authors have addressed the listability and canonicity issue, and have brought forward arguments – from language acquisition, neurolinguistics, language change, and syntax – that speak against a (purely) gestural account of agreement/indicating verbs (Meier 2002a; Capek et al. 2009; Lillo-Martin & Meier 2011; de Quadros & Quer 2011; Quer 2011; Rathmann & Mathur 2011; Wilbur 2013; Hänel-Faulhaber et al. 2014; Hosemann et al. 2018). Liddell himself does not address these arguments, but instead reiterates the crucial role of the listability problem (e.g. Liddell 2011). However, Schembri et al. (2018), who also subscribe to a gestural analysis, offer a detailed discussion of many of the relevant arguments. In the context of the present paper, we cannot address all the points they raise but will focus on those most pertinent to our proposal, that is, arguments that mainly deal with (morpho)syntactic issues.

#### (i) Listability

There are actually two facets to the listability problem: First, the fact that there is an infinite number of agreement markers; second, the observation that – in different discourse settings – one and the same referent can be marked by different loci, that is, by different agreement markers.

As has been illustrated in examples (1a) and (3), signers may point to an abstract location when a referent is not present in the physical context of the conversation. Lillo-Martin & Klima (1990) suggest that R-loci are the overt realization of abstract grammatical referential indices (which are also assigned to referring expressions in spoken languages). It is this contextually defined R-locus that will be copied onto the agreement target (see also Aronoff et al. 2005). Lillo-Martin & Meier (2011) assume that there is only one agreement morpheme for non-first person, which is unspecified for locus. In other words, they “distinguish the physical spatial locations toward which a signer points from the notion of a R(eferential)-index, an abstract grammatical device indicating reference within and across sentences” (Lillo-Martin & Meier 2011: 99).

Similarly, Quer (2011: 190), adopting arguments first brought forward by Wilbur (2008), points out that “physical points in space are actually irrelevant as such: What counts for the linguistic system is how they can be interpreted categorically as referential locations or loci”. As highlighted by Wilbur (2013), morphemes with indeterminate, contextually determined form are also attested in spoken languages, for instance in reduplication processes whereby part of a stem is copied in order to spell out some grammatical feature. In a language that realizes nominal plurals by means of (total or partial) reduplication, what would be the lexical entry for the plural morpheme? Also, Aronoff et al. (2005) report cases of literal alliterative agreement in which part of a controller is copied onto an agreement target. These examples may well be of an exceptional nature, but still, they are testimony to the fact that contextual determination of the form of inflectional morphemes is an option even in spoken languages.

The second facet of the problem is related to the issue that SL agreement does not involve stable formal or semantic properties of the DP that controls agreement. But again, agreement in spoken languages may also involve transient properties.<sup>13</sup> A famous example are languages

<sup>13</sup> Note that in SLs, the relevant features (i.e. the R-loci) are not inherent lexical features of the controller such as, for instance, gender in many spoken languages but are flexible and depend on the discourse context (cf. Steinbach & Onea 2016). While a DP may be linked to the ipsilateral area of the horizontal plane in discourse context A, the same DP may be linked to the contralateral area in a different discourse context B. The relevant features thus involve transient properties. This flexibility of assigning R-loci to discourse referents is a modality-specific property of sign languages, which can be compared to the flexibility of assigning topic markers to DPs in Asian languages, differential object marking in many spoken languages (Aissen 2003) or the obviative markers in Algonquian languages discussed immediately below.



with a proximate/obviative system, that is, a special system that allows distinguishing different third person referents by treating the most salient/topical/important referent as proximate, while less important entities are marked as obviative. Such a system is attested, for instance, in Algonquian languages, and it is illustrated in the following example from Plains Cree. Note that the proximate DP is unmarked, while the obviative DP takes the suffix *-a*; verb agreement crucially also registers the difference between proximate and obviative.

- (4) *Plains Cree* (Aissen 1997: 707)  
 Pakamahwew napew atimw-a.  
 hit:3 > 3.OBV man:3 dog:3-OBV  
 ‘The man hits the dog.’

The span within which one of the third person referents is maintained as proximate and all the others as obviative can be rather large, but depending on the discourse, it can in principle change after each sentence, e.g. due to a new participant being introduced as proximate or a nominal that was previously obviative now being assigned proximate. This crucially shows that one and the same referent can be associated with either inflectional value, and agreement thus does not track a stable grammatical property of the referent but rather a property that is highly discourse-dependent. Example (4) thus shows that the realization of agreement in spoken languages may depend on pragmatic properties just like the assignment of R-loci to discourse referents (cf. footnote 13). This does, however, not mean that these features do not enter the grammatical system of spoken and sign languages to realize syntactic agreement between the verb and its arguments.

Note finally that Steinbach & Onea (2016) define a modified version of Discourse Representation Theory (DRT) that directly integrates the relevant geometrical properties of R-loci. They argue that discourse referents are not linked to concrete points in the signing space but to regions that are more or less specific depending on the number of discourse referents. According to their model, R-loci are abstract referential indices that are recursively introduced in discourse by the grammatical system starting with the default pattern that the first discourse referent is linked to the ipsilateral region of the signing space. Hence, the grammatical system provides a mechanism that introduces necessary delimitations of the regions corresponding to the R-loci in the signing space. Therefore, it is not necessary to list an indefinite number of possible R-loci in the lexicon (cf. also footnote 3 above).

#### (ii) *Canonicity*

Schembri et al. (2018) refer to Corbett’s (2006) notion of canonical agreement and argue that it excludes indicating verbs in SLs. Similarly, Cysouw (2011: 153) argues that “[a]t most, directionality seems to be an extremely non-canonical form of agreement”. Schembri et al. do not, however, offer a detailed discussion of the criteria that Corbett proposes for what he considers canonical agreement. They do mention that SLs generally allow for pro-drop, a feature which – according to Corbett – is non-canonical. This example neatly illustrates that the presence of a non-canonical feature does not necessarily imply that the system as a whole would not pass as agreement. After all, many languages that clearly display agreement allow for pro-drop.<sup>14</sup>

<sup>14</sup> Actually, Corbett himself points out that this type of canonicity (i.e. lack of pro-drop) is limited to relatively few languages. As for SLs, we are faced with the additional complexity that plain verbs may also co-occur with null arguments (e.g. McKee et al. 2011 for Australian and New Zealand SLs). Lillo-Martin (1986) argues that these null arguments are licensed differently, i.e. by discourse factors. In other words: In this case, argument drop is topic-drop rather than pro-drop, similar to what has been described for Chinese, which allows for empty arguments in the absence of agreement (but cf. Bahan et al. 2000 for a different account).

Lillo-Martin & Meier (2011) also address the issue of canonicity and discuss two striking features of SL agreement in some detail: The existence of different verb classes (including backwards verbs) and the primacy of object over subject marking. While they acknowledge that SL agreement may well be non-canonical in certain respects, they also emphasize that “many of the properties that at first make sign language agreement seem unusual are in fact attested across the world’s languages” (Lillo-Martin & Meier 2011: 127).

Despite the fact that the notion of canonicity has haunted the discussion for quite some time now, Costello (2015) was the first to thoroughly apply the 20 criteria proposed by Corbett (2006) to an SL, namely LSE (see Mathur & Rathmann 2010 for a previous, yet less thorough, attempt). Four of the criteria refer to the controller of agreement, nine to the agreement target, three to the domain of agreement, three to the features involved in the agreement process, and one to the conditions for agreement. Costello’s detailed discussion of all the criteria based on LSE data reveals that the process of spatial modulation is clearly more canonical than not: For 15 out of the 20 criteria, LSE scores as canonical. Just like Lillo-Martin & Meier (2011), Costello (2015: 267) underlines that it “is important to bear in mind that most spoken languages also present varying numbers of non-canonical properties”. He provides Spanish as an example, as this language displays canonical behavior with respect to 16 out of the 20 criteria. Taken together, we follow Quer (2011), who concludes that the issue of (non-)canonicity has been overstated.

Note finally, that Schembri et al. (2018) argue that it is not the degree of canonicity but the nature of directionality in “indicating verbs” that represents the most critical aspect of the debate. They admit that examples with third person objects are “the closest approximation in sign language indicating verbs to Steele’s (1978) definition of agreement” (Schembri et al. 2018: 17). However, following Liddell’s mental space analysis of “indicating verbs”, they continue “that the directionality of indicating verbs is ultimately controlled by the real or imagined location of the referent, not by any feature that might be construed as a formal or semantic property of a controller noun phrase” (Schembri et al. 2018: 17). The main problem with this account is that the theoretical decision to analyze agreement within the theory of mental spaces directly leads to the conclusion that agreement cannot be purely grammatical by definition. However, the observation that verbs agree with (or are directed to) real locations of referents does not necessarily mean that the specification of the feature “directionality” is gestural. The movement of the agreement verb is always specified by the R-loci of its arguments. With third person referents not present in discourse, these R-loci are introduced (overtly or covertly) by grammatical default rules on the horizontal plane of the signing space (see above). With first and second person referents and with referents present in the utterance situation, the R-loci are deictically specified by the real locations of the referents. However, it is not the nature of the referent (anaphoric vs. deictic) but the geometrical properties of the R-loci of the agreement controlling DPs that matter for the grammatical realization of agreement. Note that in all cases, it is not necessary to use overt devices such as the pointing sign INDEX to introduce or identify the R-locus of a discourse referent. Like in spoken languages, highly salient discourse referents can be referred to without using a pronominal expression (for a formal semantic analysis of deictic (indexical) properties, see Schlenker 2011; to appear-a; and Maier 2017; for a formal semantic analysis of grammatical R-loci and agreement verbs, see Steinbach & Onea 2016).

### *(iii) Interaction of agreement and grammar*

Investigations of various SLs have revealed that the possibility to spatially modulate a verb closely interacts with other components of syntax. First, in some SLs, agreement verbs license a more flexible word order; for instance, as already observed by Fischer

(1975), in ASL, the basic word order is SVO, but SOV is possible with agreement verbs (cf. also Fenlon et al. 2018 for the interaction of overt agreement inflection and verb position and the discussion of Gökgöz 2013 in Section 4.5.2 below). Second, in Libras, the position of the negative particle *NÃO* is more flexible in the context of agreement verbs (preverbal or clause-final) than with plain verbs (only clause-final) (de Quadros 1999). Third, just as in numerous spoken languages, agreement inflection on the verb licenses null arguments (see Lillo-Martin 1986 and Bahan et al. 2000 for ASL; Glück & Pfau 1998 for DGS). Finally, there is the above-mentioned availability of agreement auxiliaries in some SLs. Steinbach & Pfau (2007) show that the distribution of these grammatical markers is rule-governed and language-specific.

Schembri et al. (2018: 24) acknowledge this striking interplay between verb directionality and grammar, but they argue that there “appears to be no a priori reason to assume [...] that the agreement analysis is the only account able to explain this”. After all, as they further point out, “there is a good deal of evidence to suggest that the grammar of individual spoken languages and co-speech pointing gesture also interacts in language-specific ways” (Schembri et al. 2018: 24); for recent work on the interaction of gesture and SL, see Schlenker (to appear-a; to appear-b). While this is certainly true, it is important to realize that in the relevant studies, language-specific aspects of the lexicon and grammar impact the use of co-speech gestures, and not vice versa – see, for instance, the study by Kita & Özyürek (2003), which reveals that lexical gaps and grammatical differences influence the shape of co-speech gestures accompanying the description of motion events by English, Turkish, and Japanese speakers. In addition, it has been shown that gestures facilitate the comprehension of grammatical structures (cf., e.g., Holle et al. 2012). However, there are only very few studies that demonstrate a direct impact of gesture on grammatical structures (Jouitteau 2004 is one exception). Following Schembri et al.’s claim, we would expect that the influence of gesture on grammar is much more widespread. However, there seems to be a clear asymmetry in that (spoken and sign) language affects gesture much more than vice versa. Note finally that even if we assume a (probably modality-specific) influence of gesture on grammar in SL, we still lack a formal theory that explains the impact of gesture on grammar. By contrast, grammatical accounts of agreement are not faced with this problem since they take agreement to be an integral part of grammar. We thus maintain that the interaction of verb agreement with other parts of grammar poses a challenge to gestural accounts of directionality.

#### *(iv) Diachronic variation and emergence*

Finally, the diachronic development of agreement provides evidence for the grammatical status of agreement (for a more detailed discussion, see Section 3.2.1.2 below; see also Pfau & Steinbach 2011; Steinbach 2011). Schembri et al. (2018: 27–28) acknowledge that “increasing conventionalization provides evidence of an emergent indicating verb construction system in the grammar, but not necessarily an agreement system”. Still, it remains unclear what is meant with “emergent indicating verb construction system in the grammar”. Since a similar objection holds for the hybrid model of SL agreement, we shall discuss both aspects in more detail in Section 3.2.1.2 below.

### **3.2 Hybrid approaches**

Ever since Fischer & Gough’s (1978) study on verbs in ASL, many scholars have explicitly or implicitly assumed that the spatial modification of verbs indeed constitutes an inflectional process, and as such is part of the grammar, more specifically the morphosyntax, of SLs. In fact, Padden (1983[1988]) referred to verbs that can be modified as “inflectional verbs”. In this section, we first discuss Meir’s (2002) hybrid model, which decomposes agreement

verbs into multiple components (Section 3.2.1). We refer to her account as “hybrid”, as grammatical and thematic roles are taken to determine the surface form of agreement verbs.<sup>15</sup> In Section 3.2.2, we offer arguments that challenge the hybrid approach. In the last subsection, we will discuss the hybrid account by Bos (2017[1998]), in which also both thematic and grammatical roles determine agreement, but in a different way than in Meir’s proposal.

### 3.2.1 Meir (2002)

#### 3.2.1.1 Components of agreement verbs

As has already been pointed out in Section 2, SL agreement is typologically unusual because, across SLs, only a subgroup of verbs, the so-called agreement verbs, agree with their subject and object, while plain verbs cannot be modified to express agreement. In an influential paper, Meir (2002) suggests that group membership (plain vs. agreement) is determined (i) by the Lexical-Conceptual Structure (LCS) of a verb, in particular whether it expresses transfer, and (ii) by phonological factors, which may block the realization of agreement (for a similar thematic analysis of agreement in DGS, see Keller 1998). Based on Israeli Sign Language (ISL) data, Meir (1998; 2002) proposes a unified analysis for regular agreement verbs (RAV) and backwards agreement verbs (BAV). In particular, she proposes the Principles of Sign Language Agreement Morphology in (5) (Meir 2002: 425).

- (5) a. The direction of the path movement of agreement verbs is from source to goal (thematic agreement).  
 b. The facing of the hand(s) is towards the object of the verb (syntactic agreement).

According to Meir, agreement verbs consist of three components: (i) the verb root, (ii) a directional morpheme, and (iii) a suffix denoting dative case. As for the first component, the verb root of an agreement verb, Meir assumes that it generally denotes concrete or abstract transfer. The LCS of an agreement verb is given in (6). Note that the LCS is underspecified for mapping of thematic functions onto grammatical functions ( $\alpha$  = subject,  $\beta$  = object).

- (6) spatial tier       $\left[ \text{CAUSE} \left( \left[ \alpha \right], \left[ \text{GO} \left( \left[ \ ]^{\gamma}, \left[ \text{Path} \text{ FROM } \left[ \alpha/\beta \right] \text{ TO } \left[ \beta/\alpha \right] \right] \right) \right] \right) \right]$   
 action tier       $\left[ \text{AFF} \left( \left[ \ ]^{\alpha}, \left[ \ ]^{\beta} \right) \right]$

Second, the directional morpheme DIR indicates the direction of movement of the theme argument. Crucially, it is DIR which realizes agreement with the source and goal argument and not the verb root itself. DIR is claimed to be a bound morpheme which fuses with the root. There are two DIR-morphemes, one for regular (7a) and one for backwards verbs (7b). Note that the two only differ in the assignment of grammatical to thematic functions.

- (7) a.  $\left[ \text{GO} \left( \left[ \ ]^{\gamma}, \left[ \text{Path} \text{ FROM } \left[ \ ]^{\alpha} \text{ TO } \left[ \ ]^{\beta} \right] \right) \right] \rightarrow \text{i.e. subject to object}$   
 b.  $\left[ \text{GO} \left( \left[ \ ]^{\gamma}, \left[ \text{Path} \text{ FROM } \left[ \ ]^{\beta} \text{ TO } \left[ \ ]^{\alpha} \right] \right) \right] \rightarrow \text{i.e. object to subject}$

<sup>15</sup> Similarly, Steinbach (2011) argues that SL agreement is a “hybrid category”. However, in his approach, the hybrid character, which is due to the gestural origin of agreement, gets lost in the process of grammaticalization, i.e. in the development of a morphosyntactic agreement system. The grammaticalization of abstract agreement verbs (without a thematic basis) and agreement auxiliaries are two crucial steps in the development of a grammatical category of agreement in SL.

Finally, the verb also assigns dative case to the affected possessor (i.e. the goal). The case suffix is phonologically realized by facing of the hand(s), that is, by the orientation of the palm and/or the fingertips.

Plain verbs cannot agree either because they do not express transfer (i.e. their LCS is different from that given in (6)) or because their phonological specification does not allow for fusion with DIR. The DGS plain verb LIKE in (1c), for instance, may well express abstract transfer (i.e. transfer of an emotion), but it is body-anchored and cannot be detached from its place of articulation (chest) to realize agreement.

In our alternative proposal, to be developed in Section 4 below, we maintain that phonological factors play a role in SL agreement. However, given a number of empirical and conceptual challenges that will be addressed in the next subsection, we argue against accounts which seek to explain SL agreement in terms of LCS, i.e. thematic properties, and propose that SL agreement is consistently syntactic.

### 3.2.1.2 Conceptual and empirical challenges

Meir's account of SL agreement is attractive, as it builds on modality-independent conceptual structures (Jackendoff 1990) and offers a unified account of regular and backwards agreement verbs. However, as also pointed out by de Quadros & Quer (2011) and Steinbach (2011), it is faced with some challenges, the most important of which are discussed in the following:

#### (i) *Against the agreement-transfer bi-conditional*

As mentioned above, Meir assumes that agreement is fundamentally linked to the notion of *transfer*. Her analysis relies on the assumption that agreement verbs generally have the LCS in (6) and, vice versa, that verbs that have the LCS in (6) should agree by means of movement. This generalization, however, is too strong.

First, while a DIR-component may be plausible for verbs like GIVE, TAKE, SEND, and PAY that express concrete transfer of an entity, there are also numerous agreement verbs for which it is less clear whether transfer is involved. Meir is aware of this fact, of course, and suggests that such verbs (e.g. TEACH, INFORM, ANSWER) should be understood as expressing abstract transfer. Still, we maintain that with certain verbs, the notion of transfer is far less obvious, e.g. DGS HELP (cf. Meir 2002: 423, fn. 11; Steinbach 2011; but see Bos 2017[1998] for the claim that such verbs may involve incorporated themes and thus mean something like 'give help to someone'), SEE and DEFEAT in Catalan SL (LSC; cf. de Quadros & Quer 2011), DIE in LSE (Costello 2015), and KILL in many SLs (for DGS, see Rathmann & Mathur 2005), where the classical decomposition CAUSE TO DIE clearly does not involve transfer.<sup>16</sup> More generally, the argument runs the risk of being circular in that transfer (concrete or abstract) will be postulated whenever a verb shows agreement by movement (see also below for agreement auxiliaries which can be combined with intransitive verbs that do not express any kind of transfer).

Second, there are agreement verbs that show agreement by orientation only even though semantically they seem to express (abstract) transfer; DGS examples include EXPLAIN, CRITICIZE, and STARE-AT (see Mathur 2000 for other SLs). Meir (1998) is forced to explain these gaps by means of phonological factors: Even though the verbs express transfer and

<sup>16</sup> One of the anonymous reviewers pointed out to us that – given certain assumptions – even these verbs could be argued to involve transfer, namely under the force-dynamics model of causation (Talmy 2000). While we do not want to deny the possibility that even these verbs could be classified as transfer verbs, it seems to us that once transfer is understood in such a liberal sense, the class of transfer-involving verbs will eventually encompass just about every two- or three-argument verb so that it is no longer clear whether an approach in terms of transfer makes different predictions that one in terms of syntactic transitivity (i.e. verbs agree with their objects).



are thus lexically specified for combining with DIR, the combination of [root + DIR] would lead to a phonological clash. As a consequence, unification with DIR is ruled out. This, however, seems to imply that goal and source remain unspecified in the LCS of these verbs; as a consequence, their meaning should be underspecified, contrary to fact.<sup>17</sup>

*(ii) Synchronic and diachronic variation*

Since, according to Meir, agreement by movement is thematic, and since thematic relations associated with particular verbs should be universal, we expect the same verbs to show agreement by movement cross-linguistically. This, however, is not the case. First, verbs that differ minimally in form/meaning may be plain verbs in one SL, but agreeing verbs in another SL. Even more strikingly, Fischer (1996) reports that Japanese SL LIKE is an agreement verb in Western Japan, but not in Eastern Japan. Again, at least for some of these cases, Meir could probably resort to phonological blocking, but this certainly does not work for the Japanese SL case, where the Western and Eastern variant of LIKE are phonologically identical.

Second, we also observe systematic diachronic change towards “more” agreement. For instance, while the DGS verb TRUST is reported to be a plain verb in Pfau & Steinbach (2003), it is clearly the case that younger signers now use it as a fully agreeing verb that can move between loci in the signing space. A similar change is attested for the verb TELEPHONE in both DGS and Sign Language of the Netherlands (NGT). Apparently, in both verbs the phonological specification which initially blocked agreement (i.e. body-anchoredness) is no longer active. Note that the latter verb is particularly interesting because it does not include the semantic notion of transfer. Crucially, there are no cases reported in the literature that would exemplify the opposite development from agreeing to plain verb (see Meir 2012; 2016 for empirical studies on the development of plain verbs into agreement verbs in ISL; see Senghas & Coppola 2001 for the emergence of spatially modified verbs in Nicaraguan Sign Language).

Third, the emergence of agreement auxiliaries provides evidence for the grammatical status of agreement (Steinbach 2011). Agreement auxiliaries only developed to mark agreement with plain verbs overtly, and they are not restricted to verbs denoting (abstract) transfer. Even more interestingly, agreement auxiliaries do not depend on the thematic structure of the predicate they co-occur with since they can be systematically combined with one-place predicates such as WAIT or LAUGH to extend the argument structure of these predicates (WAIT-FOR and LAUGH-AT, respectively).<sup>18</sup> We come back to the DGS agreement auxiliary PAM in Section 4.2 below.

<sup>17</sup> This problem is most obvious under a lexicalist/pre-syntactic approach to morphology, where the morphological elements are present from the start of the derivation and thus contribute to the interpretation (and which seems to be presupposed by Meir, although her assumptions are not fully clear to us). In such a model, the absence of DIR would seem to imply that there is no DIR present in syntax so that the meaning of such verbs should be underspecified. This conclusion can be avoided if the phonological conflict only obtains at PF and does not lead to a crash of the derivation. Such a solution seems more compatible with a post-syntactic approach to morphology as pursued in our analysis below. See also footnote 37 below.

<sup>18</sup> One of the reviewers inquires whether language contact might be at play in the combination of intransitive verbs and PAM, i.e. whether spoken German prepositional phrases in object position such as ‘wait for’ and ‘laugh at’ influence the development of PAM in this context. One argument for this assumption is the fact that PAM is often accompanied by the mouthing of the corresponding German preposition ‘auf’ (‘on’). Note, however, that a corpus study conducted in Macht (2016) shows that the mouthing is not obligatory (although it is quite frequent in some dialects of DGS). In addition, in many combinations, the mouthing ‘auf’ does not correspond to the preposition used in German, i.e. with ‘laugh at’ in German, the preposition *über* (‘about’) is used. And finally, in DGS, many combinations of intransitive verbs, adjectives and nouns with PAM can be found that do not have a counterpart in German. This means that language contact may have been one trigger for the initial step of the grammaticalization of PAM. However, the recent development of PAM is not influenced by spoken German anymore (see also Steinbach & Pfau 2007).

*(iii) Separate DIR-component*

As is evident from the LCS in (6), Meir assumes that verb roots are underspecified for path movement, that is, it is not specified whether path movement proceeds from subject to object or from object to subject (Meir 2002: 432). Specification of the path movement obtains only through unification with one of the two pre-specified DIRs in (7). The combination of verb root and DIR, however, is faced with a serious conceptual problem. In principle, a root should combine freely with the available DIR-morphemes. In reality, however, for every verb, only one combination is instantiated. In other words, the root of a regular agreement verb never fuses with the DIR-morpheme in (7b), and the root of a backwards verb never fuses with the DIR-morpheme in (7a).

In order to exclude the non-attested combinations, Meir (p.c.) assumes that every verb root is pre-specified for combination with a particular DIR-morpheme. This assumption, however, weakens the point of having a separate DIR-morpheme. After all, if there is a lexical specification anyway, then one might as well fully specify the spatial-thematic tier in the LCS of each verb.

*(iv) Agreement auxiliaries*

The conceptual problems addressed above concern fairly general issues which are independent of an individual SL. We now return to DGS data that cast doubt on the assumption that Meir's Thematic Structure Agreement analysis can explain SL agreement across SLs. Recall from Section 2.1 that DGS belongs to the group of SLs that employ agreement auxiliaries in the context of plain verbs (Steinbach & Pfau 2007; Sapountzaki 2012). Just like agreement verbs, the DGS auxiliary PAM expresses agreement by means of path movement and orientation (see Figure 3).

PAM is a purely functional element void of lexical content. Therefore, it cannot contain a DIR-component.<sup>19</sup> Reanalyzing PAM as DIR itself is implausible because it co-occurs with plain verbs like KNOW or LIKE that do not obviously express transfer, i.e., whose second argument is a theme. Moreover, as already mentioned above, PAM can productively be used to extend the argument structure of intransitive verbs such as WAIT or LAUGH (Steinbach 2011). However, the resulting transitive meanings 'wait for' and 'laugh at' do not denote concrete or abstract transfer. Therefore, agreement expressed by PAM has to be syntactic, despite the fact that PAM includes directional path movement, which – according to Meir – is the manifestation of thematic agreement (see de Quadros & Quer 2011 for a similar argument based on Libras and LSC data). The mere fact that PAM and other agreement auxiliaries exist strongly suggests that agreement in DGS (and other SLs) involves a syntactic component and casts doubts on the idea that agreement in SLs is fundamentally thematic. Meir's approach also runs into difficulties when confronted with subject agreement marker omission, which is clearly governed by syntactic functions (see Section 4.3), and the co-occurrence of PAM with backwards agreement verbs (see Section 4.5.1).

**3.2.2 Bos (2017[1998])****3.2.2.1 The proposal**

In a 1998 conference presentation, which has recently been published, Bos also argues that both thematic and grammatical roles determine SL agreement; however, in her approach, it is the agreement marked on agreement auxiliaries that is taken to instantiate syntactically-based agreement (she does not address agreement by orientation in much detail but

<sup>19</sup> Meir (2002: 435f) does point out that DIR can appear as an independent morpheme when it expresses literal motion, as in her example HOME INDEX<sub>3a</sub> WORK INDEX<sub>3b</sub> DIR<sub>3b</sub> (no translation provided, but probably meaning something like 'to move/go/proceed from home to work'). This case, however, is clearly different from the PAM case, as DIR does express transfer in this example, and there is no lexical verb.

essentially agrees with Meir on this point that it is syntactic). She differs from Meir, though, in assuming that while this always involves transfer to a goal argument, the initial point of transfer need not always be a source but may also be constituted by a theme, namely with motion verbs and, crucially, with backwards verbs like TAKE, FETCH, INVITE, and CHOOSE.

### 3.2.2.2 Conceptual and empirical challenges

Bos' proposal is surely an improvement over Meir's hybrid account since she recognizes the importance of agreement auxiliaries. However, the other two major objections raised above against a hybrid approach still stand: Even under a very liberal understanding of transfer, there remain important agreement verbs like, e.g., SEE, DEFEAT, and KILL that fail to express transfer from source/theme to goal.

As far as we can tell, the approach also does not have much to say about variation unless a verb meaning can be conceptualized in different ways. This may perhaps be plausible for verbs like INVITE, which exist as regular and as backwards verbs and where the transfer may involve movement of the invitation to the invitee or the movement of the invitee towards the goal; for many other cases, though, especially the variation between verbs with the same meaning that agree in language A but not in dialect/language B, the proposal has nothing to offer (we hasten to add that Bos does not preclude the possibility that languages become more "syntactic" over time). Another drawback of Bos' approach is that regular and backwards agreement verbs can no longer be viewed as the mirror image of each other since backwards verbs often involve a theme rather than a source on her analysis (although it should be added that she is arguably right about the nature of the thematic roles involved, a fact neglected by Meir). For the thematic approach to work, a more complex mapping algorithm is necessary (including a hierarchy of thematic roles). Thus, the hybrid approach loses much of its simplicity and, as a consequence, one of the strongest arguments in its favor. While reference to grammatical functions is indispensable (see also Section 4.3. on their role in determining subject agreement marker omission), adhering to thematic agreement in our view not only complicates the description of SLs but also fails for empirical reasons.<sup>20</sup>

### 3.3 A clitic analysis of sign language agreement

The third perspective on SL agreement analyzes agreement markers as clitics. The intuition behind this is the following: Agreement markers share with pronominal indexical signs their locational specification. Therefore, they can be considered reduced versions of these pronouns. The fact that pronominal clitics are phonologically reduced in comparison to the source pronoun is, of course, well-known from the study of spoken languages (e.g. Berendsen 1986; Klavans 1995). As for the diachronic development, an indexical sign that appears adjacent to a verb might, in a first step, cliticize to the verb, retaining its handshape but forming a prosodic word with the verb (similar to what Sandler 1999 calls "coalescence"). In a second step, the indexical sign will undergo further phonological reduction, losing all phonological substance except its location feature (Wilbur 1999).

In a recent contribution, Nevins (2011) investigates SL agreement with respect to the clitic-affix distinction and comes to the conclusion that a clitic analysis is not only viable

<sup>20</sup> Another aspect neglected in these hybrid approaches is the fact that thematic agreement is typologically highly unusual, if it exists at all. The most famous case are certainly Split-S languages, but strictly speaking they display a split between macro-roles rather than between precise thematic roles; sometimes, the concrete split involves a certain degree of arbitrariness in that some verbs do not semantically fit into their alignment class. Furthermore, other factors such as telicity often play a role in the choice of alignment; see, e.g., Dixon (1994: Chapter 4) for discussion.

One can, of course, simply take thematic agreement to be a modality-specific feature of SLs. But in our view, the case for thematic agreement would be much stronger if it were typologically better supported.

but may in fact provide a more adequate account of SL agreement. Space constraints do not allow us to offer a detailed discussion of this complex issue. Therefore, we briefly address what we take to be the strongest arguments in favor of a clitic analysis (for similar analyses see also Fischer 1975; Keller 1998; and Barberà 2015).

The first concerns optionality of agreement and the primacy of object agreement over subject agreement. SLs display a pattern that makes sense under a clitic perspective: Not only is clitic doubling more likely to be optional than agreement, it is also commonly the case that subject clitic doubling is less frequent (and less obligatory) than object clitic doubling. The second point concerns competition effects: With ditransitive verbs, object agreement in SLs always targets the goal/indirect object, while the features of the theme remain unexpressed. This is reminiscent of the Person Case Constraint (PCC), which restricts the person values of the direct object when it co-occurs with an indirect object/goal argument.<sup>21</sup> Third, concerning distribution, SL agreement seems to pattern with clitics in that both display low selectivity w.r.t. their hosts: They can occur on auxiliaries and non-verbal elements (Nevins mentions clitics on *wh*-words in Polish for spoken languages and agreement markers on DIR in ISL and on PAM in DGS). Furthermore, the form of agreement markers in SLs is tense-invariant. Fourth, a clitic-perspective allows for a unification of agreement verbs with spatial classifier verbs, i.e. verbs like MOVE that agree with spatial (topographic) features (e.g. CAR<sub>3a</sub> MOVE(car)<sub>3b</sub>, ‘the car moves from location 3a to location 3b’). Spoken languages often have both phi-related and locative clitics; under this perspective, it is thus no longer necessary to posit two different types of “agreement” verbs in SLs (see also de Quadros & Quer 2011 on that point).

Although intriguing, we believe that upon closer inspection, these arguments are not persuasive. Concerning optionality: While the clitic perspective indeed provides a motivation for the primacy of object agreement, we will show in Section 4.3 that the omission of the subject agreement marker is arguably better characterized as an instance of default agreement since there is path movement after all: The path movement simply starts in a default location. An obvious interpretation of these facts is that one obtains default agreement. Note that one important criterion to distinguish between agreement markers and clitics is what happens if Agree fails (cf. Preminger 2009; 2011): In the case of agreement, one obtains a default marker, while with clitics, the clitic is simply absent. The situation in SLs is thus more reminiscent of agreement and would fit perfectly with the conjecture in footnote 35 that subjects bear an oblique case so that Agree fails.<sup>22</sup>

<sup>21</sup> In French, for instance, in the presence of a clitic indirect object (with any person value), a clitic direct object has to be 3<sup>rd</sup> person. This is illustrated by the following two examples:

- (i) On me le montrera (1 > 3).  
one 1SG.DAT 3SG.ACC show.FUT.3.SG  
‘One will show him to me.’
- (ii) \*On me te montrera (1 > 2).  
one 1SG.DAT 2SG.ACC show.FUT.3SG

<sup>22</sup> Gökgöz (2013: 181–184) tries to apply Preminger’s (2009: 636) diagnostic to ASL; unfortunately, he actually tests a completely different configuration: In Preminger’s Basque example, the clitic goes missing when the matrix auxiliary verb fails to agree with an argument within the complement clause; Preminger links this to a clause-mate condition on clitic doubling (clitic and goal are separated by a clause-boundary). Gökgöz, on the other hand, investigates agreement on a directional verb in a configuration where the object appears topicalized in the left periphery (‘The student, I think the other student looked at him’). Thus, on the surface, the object is structurally higher than the verb, the reverse configuration of Preminger’s test case. Gökgöz observes that object marking is unproblematic here and takes this to constitute an argument against clitic doubling. However, given that a completely different configuration is investigated, this does not tell us anything. Arguably, agreement is possible here either because the verb agreed with the object before it moved to the left periphery or the object is base-generated in the left periphery and there is a silent *pro* that the verb agrees with.



As for competition effects, as far as we know, there are no person restrictions with ditransitive verbs in SLs. The fact that object agreement always targets the goal in ditransitive constructions rather than the theme is by no means typologically unusual (cf. Dryer 1986) and can simply be understood as a locality effect because the IO is structurally higher. Furthermore, it is not universally agreed-upon that PCC-effects only occur with clitics (see, e.g., Baker 2008: 94–103 for arguments that PCC-effects occur likewise with agreement, cf. also Gökgöz 2013: 45f.).

Third, as for distribution, tense-invariance is not a helpful criterion in the case of SLs, as tense is not expressed by affixes on the verb but usually by means of adverbials. Thus, tense-related allomorphs are excluded for independent reasons. As for the occurrence with auxiliaries and non-verbal elements in SLs, while some (but by no means all) of these auxiliaries – like DGS PAM that derives from the noun ‘person’ – are of non-verbal origin, it is not obvious that they are non-verbal synchronically: In the case of PAM, the fact that it displays agreement by orientation and can be affected by negation strongly suggests that it is verbal since agreement by orientation is only found with (agreement) verbs and negation typically affects the highest verbal element in the clause (cf. Sections 4.3 and 4.4 below). In addition, Pfau & Steinbach (2013) provide an explanation why the noun PERSON developed into a verbal auxiliary used to express agreement. It is not obvious what a competing explanation for the development of PERSON into a non-verbal dummy hosting two clitics would look like. Another putative parallel between SL agreement and clitics is supposed to come from the fact that both are found with non-finite verb forms. However, it is far from clear that SLs have non-finite clauses of a type similar to that in spoken languages (see also footnote 33 and Gökgöz 2013: 49). Furthermore, agreement on non-finite verbs is found in spoken languages as well, cf., e.g., the inflected infinitives in European Portuguese.

As for unifying spatial verbs with agreement verbs, while a unification may surely seem attractive, it must be pointed out that path movement has very different meanings in the two verb classes: With spatial verbs, it denotes actual movement of a referent from one location to another (cf. Wilbur 2010 for discussion of spatial (and temporal) vs. only temporal readings of verbs with ‘path’). As discussed in Section 3.2.2 with respect to the proposal by Meir (2002), interpreting the path movement in agreement verbs as literal movement frequently fails, namely in those cases where the verb does not denote transfer. An approach that attempts to unify the two verb classes is thus confronted with the same problem as the thematic account.

Let us finally comment on four additional shortcomings: First, as far as we can tell, the clitic analysis has nothing to say about backwards verbs. Since the clitics are the actual arguments of the verbs, the reverse pattern suggests that the syntactic structure is also the reverse, with the source being projected above the goal. However, to our knowledge, not only is there no evidence for this; rather, as we will show in Section 4.3, the fact that subject marker omission consistently targets grammatical functions and not thematic ones strongly suggests that both verb classes project their argument structure in the same way into the syntax. Second, the clitic analysis is forced to assume that basic phonological features of the verbal stem (i.e. beginning and end point of path movement) assimilate to the two clitics and not vice versa, which is at least typologically quite unusual (for phonological handshape assimilation in verb-pronoun combinations in ASL, see Wilbur 1999). In addition, this assumption overgeneralizes since it cannot explain why phonological assimilation of the path movement is blocked with plain verbs. And third, for SOV languages like DGS, the clitic analysis needs additional syntactic machinery such as verb raising to derive the correct order of verb and clitics (i.e. CL<sub>SUB</sub>-V-CL<sub>OBJ</sub>) as well as agreement auxiliary and clitics (i.e. CL<sub>SUB</sub>-PAM-CL<sub>OBJ</sub>). Note finally that there is neither



synchronic nor diachronic evidence for any intermediate stage of cliticization of pronoun signs to verbs, not even in languages with emerging verb directionality like Nicaraguan SL (Senghas & Coppola 2001).<sup>23</sup>

Given these arguments, we believe that a clitic perspective on SL agreement does not provide a better account of the DGS data; whether it may shed new light on the agreement systems of other SLs is a topic we leave for future research, although we hasten to add that, as far as we can tell, many of the arguments adduced above will also apply to other SLs, including ASL.<sup>24</sup>

## 4 Proposal

In this section, we will provide a consistently syntactic account of agreement in DGS. We will only use mechanisms/assumptions that have been independently argued for in spoken languages; these will be introduced in Section 4.1. Our analysis will thus be entirely modality-independent. It will consist of four parts: We will first address the difference between plain verbs and (regular) agreement verbs and relate the asymmetries in the use of the agreement auxiliary to differences in movement of the lexical verb to *v* (Section 4.2). In the second part, we tackle backwards verbs. We propose that such derivations involve mechanisms that have been posited for ergative languages (Section 4.3). Third, we will provide an account of agreement by orientation, which we relate to participle agreement in Romance, that is, as being due to an additional Agree operation between the verb and the object (Section 4.4). In the last subsection (Section 4.5), we will address further empirical aspects of SL agreement such as the combination of agreement verbs with PAM, optionality, and differential argument encoding and show how they can be integrated into our analysis.

### 4.1 Agreement in Minimalist syntax and post-syntactic morphology

We assume a standard Minimalist system (cf. Chomsky 2000, et seq.), where agreement is modelled as a process that copies agreement features (referred to as phi-features) from controllers (so-called goals) onto the agreement target (so-called probes). Concretely, the two agreement-bearing heads *v* and T start out with unvalued phi-probes. These initiate the operation Agree, which searches for valued features in the probe's c-command domain; as a consequence, the values of the subject's phi-features are copied onto T and those of the object onto *v*, as shown in (7) and (8).<sup>25</sup>

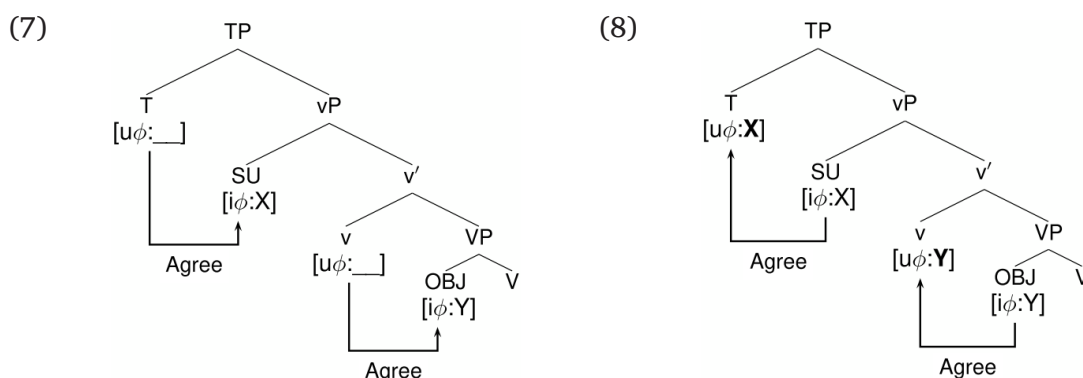

<sup>23</sup> We would like to thank one anonymous reviewer for pointing this out.

<sup>24</sup> See also Wilbur (1999), who provides evidence that in ASL, sentence final unstressed pronominal arguments of experiencer verbs are possibly being grammaticalized to verbal suffixes marking subject agreement.

<sup>25</sup> For ease of representation, we use transitive agreement verbs in the following discussion. With ditransitives, the goal argument is structurally higher than the theme (goal DPs precede theme DPs) and will therefore be the closest goal for Agree; see also Section 4.3 below.

We adopt a post-syntactic approach to morphology as in Distributed Morphology (Halle & Marantz 1993; Embick 2015), where the syntax only manipulates abstract roots and features. It is only at the level of Phonological Form (PF), where hierarchical structures are converted into linear strings, that morphological material is inserted into syntactic terminals. The insertion process, so-called Vocabulary Insertion, involves insertion of the most specific so-called Vocabulary Item, a pairing of a phonological exponent with conditions on insertion, stated in terms of morphosyntactic features of syntactic terminals. To make a concrete example, the (regular) plural of English nouns like *cat-s* is derived with a Vocabulary Item that pairs the corresponding feature [+pl] for ‘plural’ with the phonological exponent /-z/ (by convention the pairing is represented by means of a bidirectional arrow).

Vocabulary insertion will be important where our derivations involve verb movement. As is standard, this leads to the formation of complex heads as in (9). At PF, complex heads are linearized as in (10) in DGS:

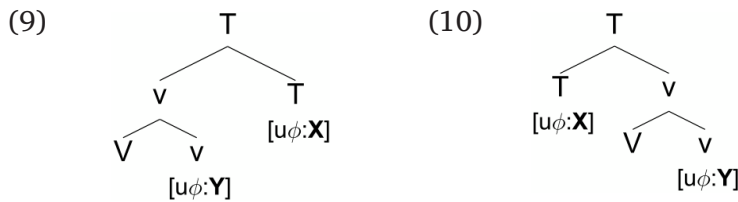

The agreement exponents will be inserted into T and v (realizing the phi-features borne by these heads), while the verb root is inserted into V. At PF, (10) is realized as path-movement from subject to object (for backwards verbs, see Section 4.3). With these basic assumptions in place, we can now proceed to the analysis of the various patterns.

#### 4.2 Regular agreement verbs vs. plain verbs

Recall that while RAVs show agreement by path movement from subject to object, in the context of plain verbs, agreement is realized on the agreement auxiliary PAM, which is realized separately from the verb root. We propose that this difference is due to an asymmetry in verb movement: While v always moves to T, the lexical V does so only in the case of agreement verbs (regular and backwards, see Section 4.3). By contrast, in the case of plain verbs it stays put. As a consequence, with RAVs, a complex head will be formed consisting of V + v + T, while with plain verbs, only v + T form a complex head. We propose to capture this lexical difference by means of a Greed-perspective on head movement (cf. Adger 2003; see Bošković 2007 for discussion of Greed-based XP-movement); that is, movement is not driven by a feature of the head projecting the landing site but rather by a feature of the moving element. For sake of concreteness, we will adopt the \*-notation from Adger (2003) to indicate that a verb needs to enter an Agree relation with another head of a certain categorial type. [\*v\*] thus means that a verb has to enter Agree with v, [\*T\*] indicates that a head has to enter Agree with T, etc. The relevant specifications are given in (11).<sup>26</sup>

<sup>26</sup> We assume that checking of the head-movement feature obtains in a classical head-adjunction structure. To ensure that this feature is not checked in-situ – e.g. when V and v c-command each other in a head-complement structure – one can postulate that checking of this feature requires asymmetric c-command between the moving element and the head it is adjoined to, which is the case under a definition of c-command as in Kayne (1994: 18). The same result can probably also be obtained if head-adjunction is replaced by head-to-spec movement followed by Merger, as proposed in Matushansky (2006). Another version of Greed-based head-movement is the reprojection approach, especially in the implementation of Georgi & Müller (2010); however, since head movement crucially results in complex heads in our approach, reprojection does not work for our purposes (unless reprojection is followed by Lowering at PF, thereby creating a complex head after all).

- (11) a. Agreement verb: [ $*v^*$ ]  $\rightarrow$  movement to v
- b. Plain verb: no [ $*v^*$ ]  $\rightarrow$  V stays put
- c. v always has [ $*T^*$ ]  $\rightarrow$  moves to T

Thus, starting with (regular) agreement verbs, V first moves to v followed by movement of the V + v-complex to T, as in (12), resulting in a V + v + T-complex, as in (13) (checked movement-related features are indicated by strike-through):

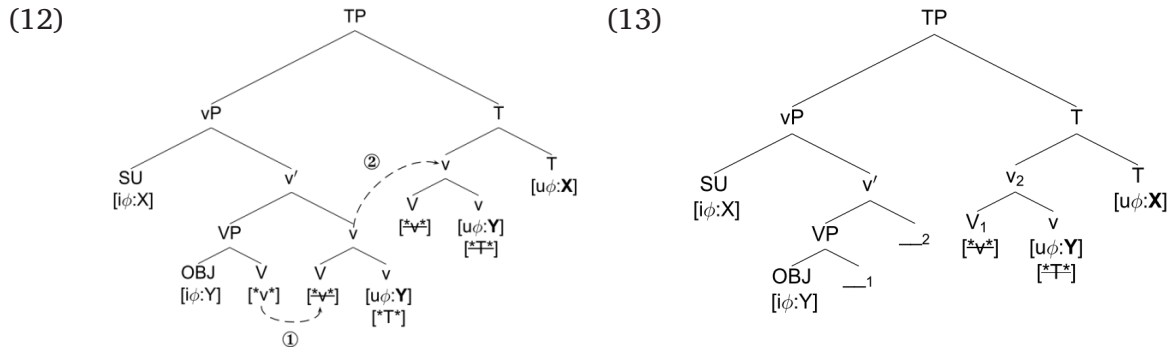

With plain verbs, the first movement step does not take place, that is, V stays put and only v moves to T, as in (14), resulting in a complex head v + T, as in (15):

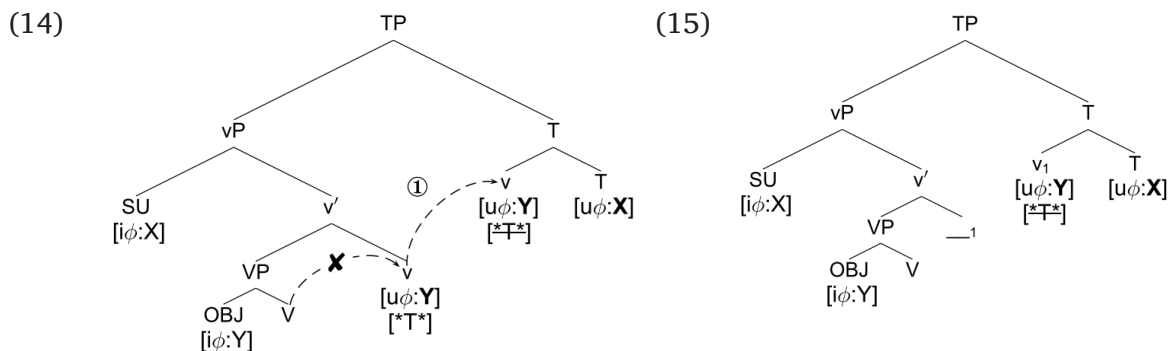

The difference in the final representation, that is, whether V forms part of the complex head or not, repeated in (16), has crucial implications for the realization at PF:

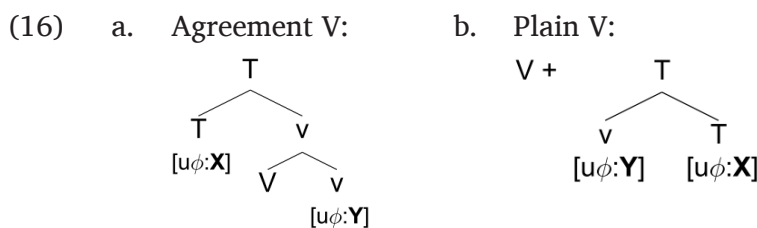

We propose that PF is sensitive to this structural difference, i.e. a different exponent is inserted, depending on the syntactic context: v is realized as zero if V is part of the complex head (hence the context restriction) and as PAM otherwise; see the Vocabulary Items in (17).<sup>27</sup>

Note that under an Attract perspective, the attracting probe-feature would have to be relativized to a lexical property of V, i.e. some diacritic identifying a verb as an agreement verb. While not impossible, the Greed perspective proposed here strikes us as more economical since the difference between plain and agreement verb has to be encoded only once, viz., on the lexical verb (while it is encoded twice under Attract, viz., on V and v).

<sup>27</sup> Note that the zero realization only affects the categorial feature of the v-head but, of course, not the agreement features it bears.

- (17) a.  $v \Leftrightarrow \emptyset / \_V$  agreement verb  
 b.  $v \Leftrightarrow \text{PAM}$  plain verb

Note that these derivations are modality-independent. The difference between RAV vs. plain verb + PAM is comparable to the synthetic vs. analytic difference in spoken language, as evidenced, for instance, by the Latin perfect, where a synthetic form is used in the active voice (18a) but an analytic form in the passive (18b). Embick (2000) proposes to capture the asymmetry in (18) by postulating verb movement to T in the synthetic perfect but no movement in the analytic perfect.

- (18) *Latin*  
 a. lauda-v-i – ‘I have praised’  
 b. lauda-tus sum – ‘I have been praised’

The synthetic-analytic split in SLs differs from splits familiar from spoken languages in that it is based on lexical properties rather than morphosyntactic features such as tense/aspect or voice. It also differs from the split in verb movement in spoken English that sets apart auxiliaries from lexical verbs and thus involves well-defined classes of verbs: The split in SLs is synchronically relatively arbitrary. It should be pointed out, though, that lexical factors have also been shown to play a role in synthetic-analytic splits in spoken languages (see, e.g., Haspelmath 2004: 658–659).<sup>28</sup>

So far, the motivation for verb movement has been only indirect in that verb movement is posited whenever there is no agreement auxiliary. As in head-final languages quite generally (cf., e.g., Haider 2010), verb movement is difficult to diagnose in DGS because the verbal elements generally line up at the end of the clause, and there are no elements in that part of the clause that could be used to delineate the vP-boundary. There is one type of diagnostic, though, that does provide independent motivation for verb movement in the case of agreement verbs: This involves negation, which treats agreement verbs and PAM alike, to the exclusion of plain verbs. DGS is a so-called non-manual dominant SL, which implies that clausal negation is commonly expressed by a non-manual marker, viz., a headshake (hs) only. The headshake, which is analyzed as a non-manual affix hosted by Neg<sup>o</sup>, obligatorily associates with the verbal element closest to it, be it an agreement verb (19a) or PAM (19b) (see Pfau 2002; 2016 for a syntactic account of DGS negation).

- (19) a. YESTERDAY POSS<sub>1</sub> MOTHER INDEX<sub>3a</sub>  $\frac{\text{hs}}{\text{VISIT}_1}$   
 ‘Yesterday my mother didn’t visit me.’

There is an obvious similarity to *do*-support in English and *tun*-insertion in Colloquial German in that without PAM, the agreement affixes would be left dangling (see Steinbach & Pfau 2007: 324f. for a comparison of PAM and *tun*-insertion). Krebs et al. (2017) show that in Austrian Sign Language (*Österreichische Gebärdensprache* – ÖGS) there are two agreement auxiliaries. Since according to the authors, they do not seem to differ in their syntactic distribution, one can assume that those speakers who use both have two vocabulary items for the context in (17b) so that two different exponents can be inserted in the elsewhere case. As the authors point out, the distribution of the auxiliaries is presumably sociolinguistically conditioned; consequently, some speakers will only have one of the auxiliaries as part of their grammar.

<sup>28</sup> A familiar case that may be somewhat more similar to the sign language split are English comparatives of disyllabic words like *clever*, where some (e.g. *easy*, *noisy*) require or at least strongly prefer the synthetic form, while others favor the analytic version (e.g. *able*, *stable*). Importantly, the variation cannot be completely reduced to phonological factors according to Hilpert (2008) – according to one of the anonymous reviewers, there is even variation between *able* and *stable*. Unlike in the choice between agreement verb and plain verb + PAM, though, there is a certain degree of optionality, i.e., certain adjectives can occur both in analytic and periphrastic form. Whether comparatives involve head-movement (rather than Lowering or Local Dislocation, cf. Embick & Noyer 2001) is an open question, though.

- b. INDEX<sub>1</sub> NEW TEACHER INDEX<sub>3a</sub> LIKE hs  
 'I don't like the new teacher.'  
 1 PAM<sub>3a</sub>

Crucially, headshake in (19b) does not obligatorily affect the plain verb, while it has to minimally accompany the agreement verb in (19a). This follows straightforwardly if negated sentences involve movement of the highest verb from T to Neg. In the case of agreement verbs, this involves the entire V-v-T-complex (20), while in the case of plain verbs, only v + T move to Neg since the lexical verb stays put (21).

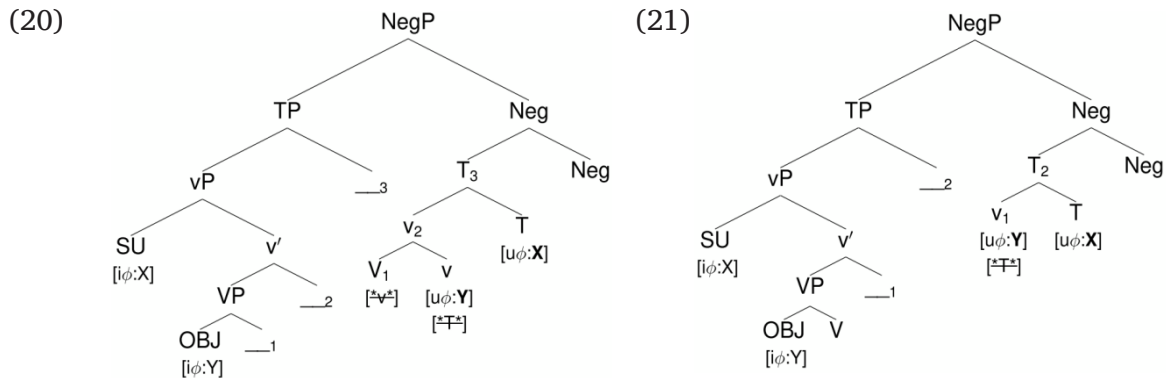

Neg is then realized as headshake over the entire complex head present in Neg. This affects either the entire agreement verb (22a) or, in the case of plain verbs, only PAM (22b).

- (22) a. agreement verb: [[[V + v] + T] + Neg]  
 b. PAM: [[v + T] + Neg]

The verb movement asymmetry between plain verbs and agreement verbs is thus independently motivated.<sup>29,30</sup>

<sup>29</sup> Evidence that V really does not form part of the complex head is particularly clear in the DGS-variety described by Rathmann (2000; 2003). A slight complication for our verb movement approach comes from aspectual marking, which can also affect plain verbs. This suggests that the aspectual head is located between v and V and that plain verbs can move up to Asp but no further, while agreement verbs move to v via Asp. Consequently, plain verbs would have to bear the specification [*\*Asp\**]. Our proposal makes predictions for SVO languages with auxiliaries such that the agreement verb in SVO sentences occupies a higher position than the plain verb in SAuxVO sentences. We leave an exploration of this issue for further research.

That the distinction between agreement and plain verbs is lexical in nature also makes it possible to describe (micro-)variation as in Japanese SL (although we do not, at this point, have any evidence that the plain verb/RAV difference also corresponds to an asymmetry in verb movement in these varieties).

<sup>30</sup> Agreement verbs can co-occur with modal verbs, in which case the (uninflecting) modal typically appears in the clause-final position following the inflected agreement verb, cf. Pfau & Quer (2007: 147, ex. 31b). We assume, deviating slightly from Pfau & Quer (2007), that modals enter the derivation in a head-position above T, e.g. Mod (the exact label is not crucial for us). They thus do not interfere with agreement. That modals are generated in a position above the inflected verb is shown by the fact that under negation only the modal verb is obligatorily affected by headshake. This follows straightforwardly under the analysis in Pfau (2002), where only the highest verb moves to Neg. Note that in DGS, modals can further move to the left, where they either occupy the sentence-initial position or the second position after the subject.

A similar observation can be made for the co-occurrence of PAM and modals. In a corpus study on PAM in DGS, Macht (2016) found 30 co-occurrences across all four dialectal regions (cf. footnote 6 above). In the vast majority of cases, viz. in 25 of the 30 co-occurrences, PAM is strictly adjacent to the plain verb (e.g. KNOW PAM CAN), as predicted under our approach (with PAM realizing a v + T complex and the modal in a head-position above it). This is also confirmed by our informants. In three examples, there is an object between the plain verb and PAM, which might involve short extraposition of the object. In two examples, the modal occupies a position between the plain verb and PAM (e.g. KNOW CAN PAM), an order whose syntax we have to leave for future research.



### 4.3 Backwards verbs

Note first that backwards agreement is not indicative of a change in grammatical relations: The agent is still the syntactic subject. This can be shown by means of subject marker omission (recall Section 2), first described by Padden (1983: 117) for ASL, which refers to the optional omission of the subject agreement marker (see Meir et al. 2007; Fenlon et al. 2018; and Section 4.5.2 below for conditioning factors). Instead of starting the movement at the R-locus of the subject, movement usually proceeds from a default location, cf. the ASL example in (23a), adapted from Padden (1983: 118). Recall that omission of the object marker is not generally observed, which is why SLs have been described as displaying primacy of object agreement. Crucially, in the case of backwards verbs, subject marker omission also affects the R-locus of the agent, so that the movement proceeds towards a default location (23b), cf. Padden (1983: 119).

(23) *American Sign Language* (Padden 1983: 118f.)

- a. WOMAN  $\emptyset$ -GIVE<sub>1</sub> NEWSPAPER  
'The woman gave me a newspaper.'
- b. ME <sub>3a</sub> TAKE-OUT- $\emptyset$  [FRIEND SISTER]<sub>3a</sub>  
'I'm taking out my friend's sister.'

If BAVs involved a reversal of grammatical functions, we would expect the agreement with the R-locus of the theme/source to be omitted, contrary to fact. Importantly, a thematic account as in Meir (2002) and Bos (2017[1998]) makes the wrong predictions here, as in one case, viz., regular agreement verbs, the R-locus of the source is omitted, while with backwards verbs, the R-locus of the goal is omitted.<sup>31</sup>

While there is thus no reversal of grammatical functions in BAVs, it is certainly the case that with respect to agreement, the object is treated like the subject and vice versa, so that we are dealing with agreement reversal. We will analyze the agreement of BAVs and the difference between RAVs and BAVs by means of an approach that has been developed in the context of ergativity (cf. Lourenço 2015 for a related idea and Pavlič 2016 for an analysis in terms of reflexive ditransitives).<sup>32</sup> Of course, agreement in SL,

<sup>31</sup> Further evidence that the grammatical relations are the same in backwards verbs comes from agreement by orientation, which consistently targets the object/goal, see Section 4.4 below.

<sup>32</sup> Given that backwards verbs instantiate agreement reversal, it may at first sight seem tempting to adopt analyses that have been proposed for (superficially) similar phenomena in spoken languages, e.g. subject object reversal in Bantu languages (Morimoto 2008) or agreement reversal in Neo-Aramaic (Kalin & van Urk 2015). However, backwards verbs do not have any of the properties that characterize the other two constructions: As shown by Morimoto, subject-object reversal is crucially related to topicality, i.e. (simplifying somewhat), reversal is only possible if the object is topical while the subject is focal; however, topicality does not play any role in the difference between RAVs and BAVs. Neo-Aramaic agreement reversal is an aspect-based split (between perfective/imperfective in a way familiar from ergative languages) and, according to the authors, results from additional agreement potential in the imperfective; furthermore, clitic doubling plays an important role, and the aspects differ in their sensitivity to the Person Case Constraint.

Again, none of this is of any relevance for the difference between BAVs and RAVs. Kalin (2015) analyzes Neo-Aramaic agreement reversal in terms of a difference in verb movement: In the reversed pattern, *v* moves across the subject to Asp in the imperfective; assuming that Agree applies at the phase level, it probes after head movement and thus targets the external argument, while T then agrees with the object. In the perfective, on the other hand, *v* targets the object while T agrees with the external argument. From a technical point of view, this could be made to work for the RAV/BAV asymmetry as well, but since there is no evidence for an asymmetry in verb movement between the two SL verb types (both verb types behave the same w.r.t. negation), we will not pursue this possibility any further.

A very different approach to reversal phenomena is the morphological approach by Baerman (2007), where reversals simply result from explicit morphological rules. Since such rules are entirely arbitrary and extremely powerful, we refrain from adopting such a solution; furthermore, under such an approach, it is not clear how subject marker omission could be handled. Arguably, it would have to apply before whatever morphological rule effects reversal. We will come back to subject marker omission at the end of this subsection.

where there is (usually) no agreement in intransitive clauses, does not instantiate proper ergativity in that this agreement does not treat transitive objects and intransitive subjects alike. Nevertheless, we adopt insights from the approach to ergativity by Müller (2009), who proposes that alignment (i.e. direct/accusative vs. reversed/ergative) is determined syntactically by the order of operations on *v*: *v* has to carry out two operations, it has an Agree probe and introduces the external argument. It is proposed that different orderings of these two operations lead to different alignments, see (24):

- (24) a. Direct/Accusative alignment: Agree > Merge  
 b. Reversed/Ergative alignment: Merge > Agree

The derivation of direct/accusative alignment is standard, with Agree between *v* and the object preceding Merge of the external argument (followed by Agree between T and the subject (SU)):

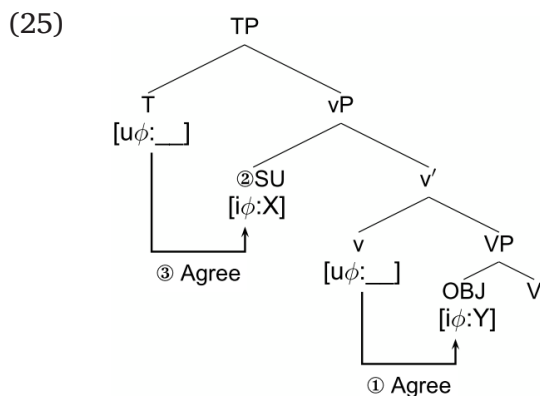

As a consequence, the features of the subject are copied onto T and those of the object onto *v*. In ditransitives, where if full NPs are present, the goal precedes the theme, *v* always agrees with the indirect object/goal argument. This is due to the fact that the indirect object is structurally higher than the theme/direct object at surface structure and thus closer to *v* (we leave open whether goal arguments are introduced in SpecVP or in the specifier of a separate applicative head; we will come back to ditransitives in the section on agreement by orientation below).

Under the reverse ordering, however, *v* agrees with the subject (Agree is assumed to be subject to m-command, and the subject is closer to *v* than the object according to a path-based definition of locality, see Müller 2009: 273, fn. 9), while T agrees with the object (there is no defective intervention in this system, cf. Müller 2009: 277, fn. 20), as illustrated in (26).

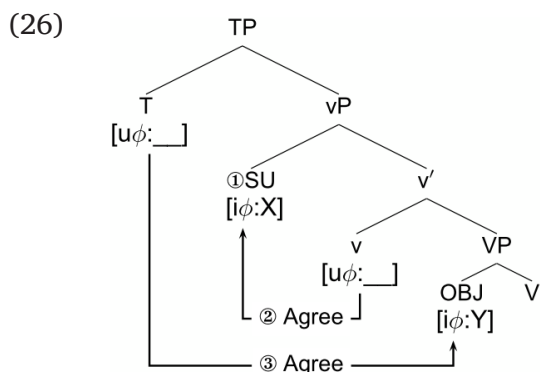

In ditransitive BAVs, T targets the indirect object/goal argument rather than the theme, because it is structurally higher.

The phi-features are thus distributed differently in the two alignment types, which has consequences for the spell-out at PF. The RAV/BAV-asymmetry in SLs can now be analyzed as resulting from the use of the direct/“accusative” v in RAVs and the reversed/“ergative” v in BAVs.<sup>33</sup>

Recall from above that complex heads are linearized as in (27) in DGS:

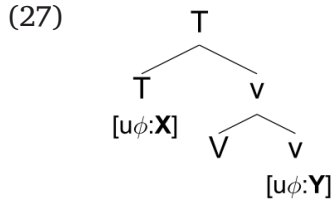

Given the different Agree operations, we find the following features on the functional heads in the two alignment types:

- (28)
- a. T-V-v → direct: RAV  
SU-V-OBJ
  - b. T-V-v → reversed: BAV  
OBJ-V-SU

At PF, this is realized as path movement from subject to object with RAVs (28a) and as movement from object to subject with BAVs (28b).

What is special about the reversal in backwards verbs is that it is a property of certain verbs, not a property of certain tenses/aspects or clause types (as in tense/aspect-based split ergativity/Neo-Aramaic agreement reversal) or a phenomenon governed by information structure. Since the different alignments are encoded on v, this implies that there will be a selectional relationship between v and V – with the “ergative” v only selecting BAVs and the “accusative” v selecting RAVs. This selectional property seems to be a remnant of the thematic origin of verbal agreement in SL discussed in Sections 3.2.1 and 3.2.2 above.

We have not been able to find a perfectly parallel analogue in spoken languages, but there are cases of split-ergativity where the split is at least partly conditioned by lexical factors. This concerns for instance clause-type based splits as, e.g., in Sierra Popoluca, where certain clause types, viz., temporal adjunct clauses headed by the native temporal complementizer and complement clauses of certain intransitive verbs, take accusative

<sup>33</sup> We have adopted this theory of ergativity because it allows for a very simple formulation of the reversal between RAVs and BAVs. Alternative approaches to different alignments developed in the context of ergativity may work as well. They generally differ with respect to the location of the Agree probes (e.g. both probes on T, both probes on v, or one on T and one on v as proposed here; see Deal 2015 for a recent overview). An approach where both probes are on v or on T may be a possibility as well to capture BAVs. However, given that one needs to establish a link between the lexical verb and the functional head responsible for reversal, postulating at least one of the two agreement probes on v is technically more straightforward. Locating both probes on v (rather than one on T and one on v) may thus be an alternative.

Unfortunately, the necessary empirical evidence to choose between the two options does not seem to exist: The crucial diagnostic that is usually applied to determine the location of the probes is the behavior in non-finite clauses, i.e., which argument goes missing and which agreement morphemes get lost. However, since SLs do not have non-finite clauses in a straightforward sense (see Padden 1983[1988]; Göksel & Keleşir 2016), this diagnostic cannot be applied: Tense is not marked on the verb, and agreement verbs that occur in the translational equivalents of non-finite clauses are fully inflected and thus license pro-drop. Thus, one cannot check which argument goes missing in non-finite clauses (even if they existed in SLs). Finally, since intransitives do not agree, one does not know whether T is involved in agreement at all. Given the absence of the relevant diagnostics, we will not dwell on this any longer.

alignment, while ergative alignment is prevalent elsewhere (e.g. in temporal clauses headed by a Spanish complementizer; cf. Marlett 1986). Another possibly related case may be deponent verbs in languages like Latin where the inflection of certain verbs (that do not form a natural class, see Embick 2000) is systematically passive despite transitive syntax (29).<sup>34</sup> As with agreement reversal in SLs, this is a lexical property of individual verbs (or roots).

- (29) *Latin* (Embick 2000: 191)
- a. hort-or – ‘I exhort.’
  - b. horta-t-us sum – ‘I have exhorted.’  
(cf. laud-or ‘I am being praised.’; lauda-t-us sum – ‘I have been praised.’)

The primacy of object agreement, that is, the fact that subject markers can be omitted, while object markers cannot, does not yet follow from our analysis. The challenge posed by the phenomenon is that under our analysis, this involves features on different heads, as shown in (30).

- (30) a. RAV:  $\bar{F}$ -V-v  $\bar{S}\bar{U}$ -V-OBJ  
b. BAV: T-V- $\bar{v}$  OBJ-V- $\bar{S}\bar{U}$

One can formulate an impoverishment rule that optionally deletes the features of the subject (Halle & Marantz 1993); since this affects different heads, depending on the verb type, the impoverishment rule requires a context restriction. The obvious feature for such a restriction is case: Under the assumption that case assignment precedes agreement and that external arguments always get the same case, one can assume that under Agree the case-features of the arguments are copied onto the functional heads as well. The impoverishment rule can then refer to whatever case characterizes external arguments (cf., e.g., Georgi 2013).<sup>35</sup>

We conclude the discussion of backwards verbs by briefly commenting on two alternative proposals that have been brought forward. De Quadros & Quer (2011) also argue against a thematic account for BAVs, and the arguments they offer intersect with those that we presented in Section 3.2.2. Based on data from Libras and LSC, they claim, however, that BAVs should be removed from the group of agreement verbs proper and should actually be treated as “handling [classifier] verbs with path, where the path actually agrees with locations and not with syntactic arguments”, that is, BAVs are analyzed as spatial verbs like MOVE. Consequently, with BAVs, the agreement is locative and not syntactic. Obviously, for this solution to work, they have to assume metaphorical transfer from a literal handling operation to an abstract one, for instance, for BAVs like UNDERSTAND (in LSC) and INVITE. However, it remains unclear why such metaphorical transfer

<sup>34</sup> The parallel is not perfect in that the different agreement paradigm is not due to the fact that the verb agrees with a different head but rather due to its having a lexical specification that has consequences at PF.

<sup>35</sup> While doable, such a solution leaves unexplained the fact that impoverishment usually affects features of the subject (but see Section 4.5.2 below). An alternative but more speculative solution consists in assuming that the subject in SLs bears quirky/oblique case and, as in other languages, cannot be the goal for Agree (cf. Bobaljik 2008). As a consequence, the probe targeting the subject does not find any features and is deleted/valued by default. Agreement would then become possible if the opacity-inducing features of the external argument are deleted before Agree. This could be done by means of impoverishment, either in syntax, as in Keine (2010), or at PF, as in Arregi and Nevins (2012) (thus before the features are copied). It would work for both RAVs and BAVs (and would be compatible with both Agree-based and Dependent-Case-based models of Case). The obliqueness of the subject’s case might be motivated diachronically, as a residue of the oblique encoding of source in the expression of transfer (assuming that this is what SL agreement originates from). With BAVs, the obliqueness may be related to its origin as a goal (crucially, though, regular (indirect) objects, which often function as goals, must not be oblique synchronically).

should only be observed with BAVs and not with RAVs. The verb ASK in DGS, for instance, features a handshape that could readily be analyzed as a handling handshape ('to take an object from the mouth'), but it is an RAV and not a BAV.

Geraci et al. (2016), working on Italian SL, maintain that BAVs belong to the class of agreement verbs but claim that they are actually not backwards, as they do not agree with the subject/agent, but rather with two internal arguments. By means of syntactic tests, Geraci et al. demonstrate that the endpoint of the path movement does not coincide with a subject/agent. That is, in a sentence like 'Mary copied the text from the book', the verb COPY moves from the locus of the book to the locus of the copied text, not the locus associated with Mary. While at least some verbs that would usually be classified as BAVs thus no longer belong to this group, it is also clear that they are not RAVs (according to Geraci, they are middle/pseudo-passive constructions). Also, while thought-provoking, the analysis cannot be extended to DGS, as in DGS, the end point of the movement of typical BAVs clearly coincides with the locus associated with the agent/subject.<sup>36</sup>

#### 4.4 Agreement by orientation

Agreement by orientation raises one major challenge for any syntactic analysis of SL agreement: It is consistently direct, that is, it always targets the object, even with BAVs. Hence agreement by movement and agreement by orientation cannot be treated as a case of multiple exponence of just one Agree relationship. Rather, agreement by orientation has to have a separate source.<sup>37</sup>

The crucial observation for the analysis comes from the fact that PAM also displays agreement by orientation. Given that PAM has been analyzed as the realization of *v*, agreement by orientation must be the result of an Agree operation that is also initiated by *v*. Since it always targets the object, this Agree operation obviously does not interact with the one that is responsible for the two different alignments. Therefore, we propose that there is an additional probe on *v*, which is ordered both before the external Merge of the external argument and the phi-probe. The closest goal at this point of the derivation will be invariably the (indirect) object. At PF, the probe-feature is realized as orientation towards the object.

Importantly, the probe that leads to agreement by orientation is not a full phi-probe: There is good evidence that it only involves [person (=  $\pi$ )] but not number.<sup>38</sup> This becomes clear e.g. in the (collective) plural form of verbs like DGS HELP or ANSWER, where orientation changes towards the object during path movement, but remains constant on the arc that marks plural.

<sup>36</sup> A somewhat similar analysis has been put forward in Pavlič (2016). Pavlič argues that BAVs are reflexive ditransitive verbs that agree with an oblique source argument and an indirect (reflexive) goal argument which might be bound by the subject if it is an animate beneficial argument. As a consequence of this analysis, BAVs show regular thematic agreement between source and goal as proposed by Meir (1998; 2002). Accordingly, Pavlič's analysis is faced with the same problems as Meir's and Bos' hybrid accounts discussed in Sections 3.2.1 and 3.2.2 above.

<sup>37</sup> It has been observed that not all verbs show agreement by orientation, e.g. GIVE and ASK in DGS. Furthermore, there seem to be verbs that show agreement by orientation only (but not by path movement). In both cases, there are good reasons to believe that the absence of agreement is due to phonological reasons. Specifically, (i) verbs whose phonological specification prevents path movement cannot express agreement by means of movement; (ii) verbs in which the orientation of the fingertips or palm is neither away from nor towards the signer's body, i.e. verbs that do not involve facing (Meir 2002), cannot express agreement by orientation (e.g., in DGS GIVE and ASK, the palm is oriented upwards and the fingertips are oriented contralaterally). Given the post-syntactic approach to morphology that we presuppose here, the relevant Agree operations will have taken place in syntax but remain unrealized at PF because of a phonological clash. Thus, the agreement exponents inserted into *v*/T arguably undergo last resort deletion (and thus do not cause a crash of the derivation).

<sup>38</sup> An alternative to a person feature would be the feature [uIdent] proposed in Costello (2015), who argues that postulating an [uPerson] feature for sign languages leads to certain complications. Since this issue is orthogonal to the questions pursued here, we stick to the traditional feature for ease of legibility.



The order of the probes on *v* is thus as follows (*uD* is the label for structure-building features that introduce the arguments, the prefix ‘*u*’ refers to ‘uninterpretable’ thereby specifying that the corresponding features do not contribute to the meaning of the sentence):

- (31) a. regular agreement verbs: *v* [*uperson*] > [*uphi*] > [*uD*]  
 b. backwards agreement verbs: *v* [*uperson*] > [*uD*] > [*uphi*]

The following diagrams show the full derivation of regular (32a) and backwards agreement verbs (32b).

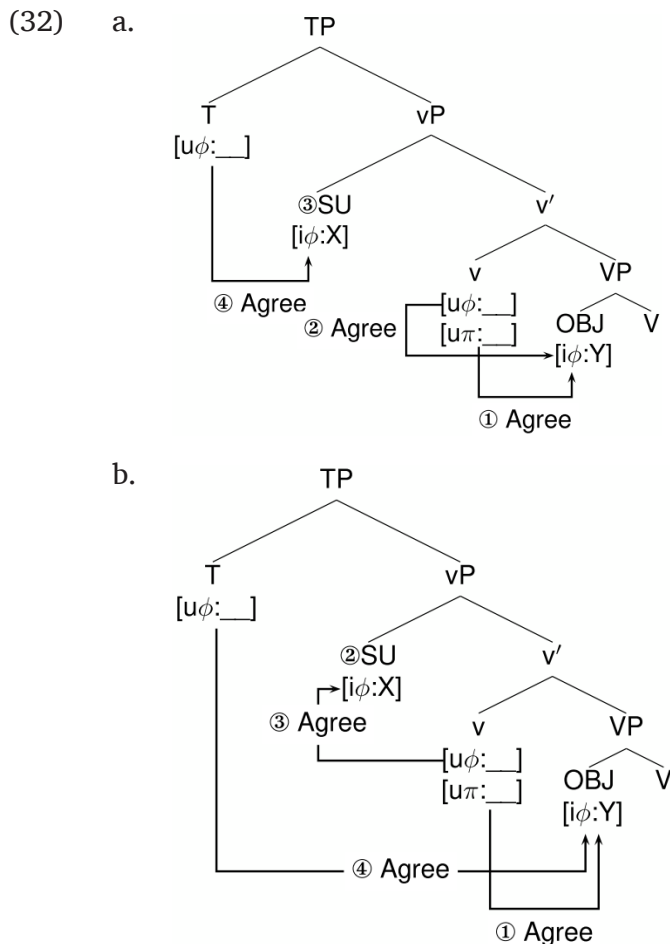

Note that as a side-effect, the fact that the additional probe on *v* only involves person avoids complications with the Activity Condition (Chomsky 2000; et seq.): Since the object is not affected by a complete *phi*-probe, it remains active for further Agree with *v*. Our analysis of agreement by orientation thus bears certain similarities to participle agreement in Romance (and beyond), which only involves [Number] and [Gender], so that in the case of unaccusatives (and passives), the subject remains active for Agree with T, see (33).<sup>39</sup>

<sup>39</sup> Agreement of the same DP with several heads in the clause, is, of course, also found in auxiliary-verb constructions in many languages (cf. e.g. Baker 2008), in which case all *phi*-features can be involved. Different notions of the Activity Condition are thus involved in the two cases, one related to *phi*-completeness, one to case marking.

The possibility of multiple probes on the same head has been postulated for a number of phenomena, including agreement in ergative languages (e.g. Bobaljik & Branigan 2006), and more generally for languages that show agreement with direct and indirect objects at the same time (cf. Baker 2008: 99ff.). It may not be coincidental that in the cases described by Baker, as in SL agreement, this usually goes along with one of the probes copying only a subset of the features (so-called “two and a half-agreement”, viz., PCC-effects). A proposal where multiple probes on the same head target the same goal is offered by, e.g., Georgi (2013), who analyzes agreement in local person scenarios.

- (33) *French*  
 Les fille-s sont venu-es.  
 the.PL girl-PL be.3PL come-FEM.PL  
 ‘The girls have come.’

#### 4.5 Further issues

So far we have presupposed, idealizing somewhat, that plain verbs obligatorily occur with PAM and that PAM and agreement verbs are in complementary distribution. Furthermore, we have assumed that all arguments trigger agreement irrespective of their semantic properties. There is some indication in the literature that alternative agreement patterns can occasionally be found and that agreement can be restricted to arguments with certain grammatical, semantic and pragmatic properties. We will briefly address these issues in what follows and outline how our analysis can be refined to integrate them.

##### 4.5.1 Co-occurrence of PAM + agreement verb

It has been mentioned in the literature that agreement auxiliaries do not exclusively occur with plain verbs (Steinbach & Pfau 2007). Rather, there are occasional examples where they co-occur with an uninflected version of agreement verbs, cf. (34a). Additionally, the combination with inflected agreement verbs, both regular and backwards, has also been claimed to be attested, cf. (34b, c). Crucially, the path movement on the auxiliary is always from subject to the object, even with backwards verbs (another indication that agreement on the auxiliary must be syntactic). Data like (34b, c) have also been reported for NGT (Bos 2017[1998]) and LSC (de Quadros & Quer 2008):

- (34) a. NEXT WEEK INDEX<sub>1</sub> INDEX<sub>3a</sub> ASK<sub>1</sub> PAM<sub>3a</sub>  
 ‘I will ask her/him next week.’  
 b. POSS<sub>1</sub> FRIEND INDEX<sub>3a</sub>, INDEX<sub>1</sub> TRUST<sub>3a</sub> PAM<sub>3a</sub>  
 ‘As for my friend, I trust him.’  
 c. NEXT WEEK INDEX<sub>1</sub> INDEX<sub>3a</sub> INVITE<sub>1</sub> PAM<sub>3a</sub>  
 ‘I will invite her/him next week.’

In a recent questionnaire study, Murmann et al. (2013) investigate the combination of inflected and uninflected agreement verbs with PAM. They report that with inflected agreement verbs, the version without PAM as in (1a) above is rated significantly better than the corresponding version with PAM (as in (34b)). By contrast, the combination of PAM with uninflected agreement verbs (as in (34a)) receives significantly better ratings than zero marking (i.e. uninflected agreement verb without PAM), but it is still judged much worse than inflected agreement verbs without PAM as in (1a).

Given these results and the fact that detailed studies in other SLs on the combinatorial possibilities of agreement auxiliaries and (un)inflected agreement verbs are largely lacking, the status of data as in (34) is not fully clear. Should further research corroborate the existence of these additional patterns, they could be accommodated as follows under our analysis. The version in (34a) suggests that (for whatever reason) agreeing verbs only optionally move to *v*, i.e., the movement diacritic on them is optional. If present, there is movement to *v*, leading to the canonical pattern with inflection on V as in (1a), (12) and (17a) above. In the absence of the movement diacritic (as in (34a)), V stays put and *v* is realized as PAM as in (14) and (17b) above. The patterns in (34b, c) require a different analysis. Since we have taken agreement verbs to move to *v*, while PAM is the spell-out of *v* in the absence of verb movement, the two should not be able to co-occur. Given the pattern in (34c), the multiple agreement in (34b, c) also cannot be analyzed as an instance

of multiple exponence of just one Agree relationship. Postulating an additional agreement projection to host the auxiliary does not strike us as a very interesting possibility. We would like to propose instead that the examples in (34b, c) are biclausal. Thus, the sentences in the pair in (35) receive a very different analysis despite their surface similarity:

- (35) a. MOTHER INDEX<sub>3a</sub> NEIGHBOR INDEX<sub>3b</sub> LIKE<sub>3a</sub> PAM<sub>3b</sub> [monoclausal]  
 ‘(My) mother likes the neighbor.’
- b. MOTHER INDEX<sub>3a</sub> NEIGHBOR INDEX<sub>3b</sub> TRUST<sub>3b 3a</sub> PAM<sub>3b</sub> [biclausal]  
 ‘(My) mother trusts the neighbor.’

While (35a) is the familiar case with the verb staying put and *v* being spelled out as PAM, (35b) actually involves a biclausal structure with the Aux taking a TP-complement as shown in (36).

- (36) [<sub>TP</sub> SU [<sub>TP</sub> OBJ V + v + T] v + T]  
 ↓  
 PAM

There are independent differences between the two structures that provide evidence for our proposal; they all very much suggest that the verbs are structurally closer to each other in the former (not separated by a clause boundary): First, modal verbs can intervene between *V* and PAM in (35b), but not in (35a) (for the combination of modals and PAM, cf. also footnote 30 above). Second, cliticization of PAM to two-handed verbs by means of coalescence (Sandler 1999) is only possible in (35a) but not in (35b). Third, subject pronoun copy between verb and PAM is possible in (35b) but not in (35a). Fourth, we have provisional evidence that there is a difference in spreading of the headshake: While headshake on PAM with optional spreading onto the verb is possible in both examples, headshake may also be on the verb only in (35b). Again, this suggests that we are dealing with two separate clauses: The inflected verb in (35b) would be the structurally highest element in the dependent TP so that it may be affected by Neg alone (Neg would thus be projected in the dependent TP, while the version with headshake spreading onto both verbs requires Neg to be projected in the matrix clause in (35b)). In the literature that discusses multiple agreement, it has occasionally been observed that multiple agreement adds emphasis (probably *verum focus*). Arguably, the marked biclausal strategy triggers an M-implicature (Levinson 2000) ( $\approx$  ‘My mother trusts the neighbor, she really trusts him’).<sup>40</sup>

#### 4.5.2 Optionality and differential argument encoding

As discussed at the end of Section 2 and in Section 4.3, (manual) agreement is not always obligatory (see De Beuzeville et al. 2009 for Australian SL; Costello 2015 for LSE; Fenlon et al. 2018 for BSL).<sup>41</sup> The optionality raises two (probably related) issues: First, how is

<sup>40</sup> It remains to be determined whether the biclausal structure involves raising or control. Given the semantics of the examples, a raising analysis is more obvious. However, given that subject and object are normally deactivated after Agree with *v/T*, this is not so straightforward (movement of the subject from the embedded TP to the matrix TP would arguably instantiate Hyperraising). Given the uncertain status of multiple agreement, we will not pursue this any further.

The biclausal analysis will not readily extend to cases of multiple agreement in Southern varieties of DGS (Bross 2018) or NGT (Bos 2017[1998]), where the auxiliary does not occur clause-finally but rather before the inflected verb or between subject and object. At least w.r.t. Southern varieties of DGS, this may indeed suggest that PAM has a different function, viz., as a differential object marker, see the next subsection.

<sup>41</sup> It is well-known that SLs also use non-manual devices such as eye gaze and head tilt to mark various grammatical functions in general and R-loci in particular, that is, a lack of manual agreement marking does not necessarily mean that agreement is optional. Agreement may well be realized non-manually in many instances (for non-manual agreement marking see Section 5).

the optionality to be implemented technically? Second, are there any factors that govern the distribution of the two variants (manual agreement and lack of manual agreement)? For DGS, optionality of (manual) agreement has not been investigated in detail yet, but we consider it likely that similar factors as in other SLs will be at work: Next to grammatical factors such as the person or animacy value of the agreement controller's features which have been found in various SLs (Janis 1995; Rathmann & Mathur 2002), discourse factors also seem to be involved (coreference with a null argument in the previous clause or role shift (constructed action), cf. Fenlon et al. 2018).<sup>42</sup>

We would like to stress at this point that optionality in the overt expression of certain morphosyntactic features is not an exclusive property of SL agreement, but rather occurs in spoken language as well. Furthermore, that agreement is sensitive to the person, animacy and specificity value, e.g. is triggered only by local person, animate or specific arguments, is also widespread in spoken languages and represents an instance of differential argument encoding (Corbett 2006). Thus, optionality that is governed by grammar-internal factors is by no means an argument against a grammar-based approach to agreement; rather, the fact that similar factors seem to be at play in both spoken and sign languages can be considered an argument *in favor* of treating SL agreement in the same terms as spoken language agreement.

As for the technical implementation (an issue that, of course, arises for all approaches to SL agreement), we will be brief with respect to non-grammatical factors since the goal of our paper is to describe the agreement *system* rather than its use. However, this should not be taken to imply that they are of lesser importance; rather, they are simply orthogonal to and outside the purview of a syntactic analysis (but independently constitute an important topic for further research). From the point of view of the grammar, all that is needed is a mechanism that generates an agreement verb without inflection (next to the variant with inflection). The impoverishment rule discussed in Section 4.3 is a straightforward possibility. The grammar can thus generate two possible outputs whose selection will be determined by discourse contexts.

Turning to grammatical factors such as person and animacy, obvious options for incorporating these factors within recent Minimalist or Optimality-theoretic work would be (i) by means of context restrictions on marker insertion (for instance, Agree copies animacy/specificity features in addition to phi-features onto v/T, and the Vocabulary Items for the agreement features are contextually restricted to v/T heads that bear certain animacy values, recall Section 4.3), (ii) by means of scale-driven impoverishment (cf., e.g., Keine 2010, where impoverishment is conditioned by Silverstein hierarchies), (iii) by means of relativized probing (the phi-probes on v and T only look for certain person/animacy feature values; cf. Nevins 2007; Preminger 2011; Georgi 2013), (iv) by underspecification of NPs for certain values (e.g. 3<sup>rd</sup> person arguments have no person features so that verbs will not agree with them in person, cf. Nevins 2007), or (v) that only arguments with certain semantic features need to be licensed by Agree (and thus trigger agreement), but not all arguments, see Kalin (2018).

<sup>42</sup> Murmann et al. (2013) address the question whether PAM can only mark agreement with animate objects. The results of this questionnaire study show that with inanimate objects, the ratings for plain verbs with PAM are significantly worse than those for plain verbs without PAM. With animate objects, the combination of plain verb and PAM is preferred. This means that PAM has a strong preference to agree with animate objects. Note finally that Bross (2018) argues that PAM is not an agreement auxiliary but rather a device for differential object marking, akin to, e.g., Spanish *a*. His claim is based on the observation that (in the Southern variety of DGS he investigates) PAM can occur with agreement verbs (see also the previous subsection on double agreement) and that it, according to him, only marks object agreement but not subject agreement.

A reviewer has drawn our attention to the work of Gökgöz (2013), who argues that object agreement in ASL cannot be equated with agreement as described for spoken languages like English or German. He observes that agreeing verbs have a preference for the OV- instead of the canonical VO-order; furthermore, agreement is more likely with D-linked/presuppositional arguments. He concludes from this that no c-command is needed between the verb and the object for agreement to obtain; rather, agreement is licensed by an operator outside of VP.

As far as we can tell, what Gökgöz describes is a familiar case of differential object marking combined with D-linked arguments moving out of the nuclear scope (roughly, the VP). As discussed above, it is well-known from the languages of the world that arguments may be marked differently depending on their referential and animacy properties. In Turkish, for instance, only specific direct objects are marked with accusative case. The difference in marking can be accompanied by structural differences; as described for ASL, specific/referential objects often move out of VP, a fact that holds more generally in free word order languages (including those without differential object marking such as, e.g., German).

As for his arguments that object agreement in ASL does not represent an instance of agreement proper, the facts discussed in the thesis by no means show that no c-command relationship between verb and object is necessary; after all, whatever the surface position of the object, it will be c-commanded by the verb at the point of Merge so that Agree will always be possible. Since positions outside of the nuclear scope are generally associated with presuppositional/D-linked material, we do not see the need to postulate designated operators. Putative evidence for the presence of an operator and a variable on the verb is supposed to come from gapping, which is degraded with agreement verbs. This is linked to the ban on vacuous quantification – with the verb gone, the operator would have nothing to bind. However, if gapping only involves PF-deletion, as is standard, the fact that the agreement verb is not overtly realized should not affect the binding of the variable, which would still be present in syntactic structure. Whatever the cause of the unacceptability of gapping with agreement verbs, this cannot easily be linked to the presence of an operator outside of VP and a variable on the verb. Thus, while the facts discussed in Gökgöz are truly interesting and merit further investigation, the conclusions drawn from it strike us as unconvincing. Consequently, instead of showing that object agreement in ASL is a very different phenomenon, Gökgöz' dissertation rather provides further evidence that agreement is subject to similar constraints in both spoken and signed languages.

The connection between specificity, a high clausal position and agreement can be captured by assuming that only objects that undergo object shift (i.e. leave the VP) become accessible to the object agreement probe; objects which for semantic reasons do not undergo object shift then cannot be targeted for reasons of locality (assuming that VP constitutes an opaque domain); one has to assume for that case that probing can fail without leading to a crash of the derivation (Preminger 2011); object agreement in Amharic has been described in these terms (cf. Baker 2012), which would thus seem to be rather similar to object agreement in ASL.

## 5 Discussion: A recipe for sign language agreement

We have proposed a consistent and formally explicit syntactic analysis of SL agreement that captures the relevant empirical aspects of agreement in DGS and similar SLs (for typological variation, see below). Given that this success could not be taken for granted, we consider this an important result in itself. Only if one adheres to a coherent and explicit framework does it become clear to what extent an analysis can be successful, where it runs into difficulties, and how it relates to other (explicit) work on agreement in



both spoken and sign languages. Note that previous syntactic work on SL agreement tends to be stated in largely descriptive terms. Therefore, it cannot easily be assessed whether it can actually account for what it sets out to explain and how SL agreement compares to agreement in spoken languages. Next to this methodological point, our syntactic analysis also offers a number of important conceptual, empirical as well as analytical advantages.

First, it only makes use of assumptions/mechanisms that are independently motivated and have been proposed to account for agreement in natural languages. By contrast, previous work on agreement in SLs made use of devices whose role in spoken languages is questionable at best. This concerns, for instance, thematic agreement in general (recall footnote 20 above), as well as the fact that some parts of the agreement system are sensitive to syntactic function (subject marker omission, agreement by orientation, agreement on the auxiliary), without an obvious reason why there should be exactly this division of labor. SL agreement is thus largely described as a peculiar phenomenon of its own, resulting in a typologically rather unusual agreement system with only few links to spoken languages. In contrast, our analysis systematically relates SL agreement phenomena to agreement phenomena in spoken languages. For instance, the use of agreement auxiliaries is related to the synthetic/analytic split, agreement by orientation patterns similar to participle agreement, and backwards verbs bear similarities to agreement reversal phenomena. As a consequence, there is no need to treat SL agreement as exotic or non-canonical. Given that SLs are otherwise regarded as canonical natural languages with respect to many other grammatical phenomena, we take this to be a positive result. In our view, scholars who argue that SL agreement is completely different and does not follow universal (modality-independent) grammatical patterns would have to demonstrate that their set of assumptions also allows them to explain, and not just describe, the complexities of the phenomenon under discussion.

Second, all agreement phenomena are constrained by configurational properties and are thus determined in a uniform way. Reference to grammatical functions or thematic roles is unnecessary. No special thematic hierarchies are needed nor does agreement on auxiliaries require a different account. Note, for instance, that the fact that ditransitive verbs agree with the goal, while transitive verbs agree with the theme (w.r.t. both movement and orientation) follows from the simple fact that these are the arguments that are structurally closest to the Agree probes on *v*. It is thus unnecessary to treat transitive agreement verbs as underlyingly ditransitive (with an incorporated theme); the circularity problem with the notion of transfer can thus be avoided.

Third, our account of the difference between plain verbs and agreement verbs (an asymmetry in verb movement) is independently supported by differences in negation marking; as a consequence, the distribution of the auxiliary need not be stipulated but can be related to independent differences in syntactic structure (i.e. whether *V* is part of the complex head or not) and motivated by the fact that it provides a host for agreement morphemes that would otherwise be left dangling. Previous especially thematic work has to stipulate that agreement auxiliaries have to occur with plain verbs; however, if agreement is essentially thematic, why should there be a need for an element that agrees in a completely different way (i.e. in grammatical functions)? On our analysis, agreement on agreement verbs and on the agreement auxiliary serves the same function, which accounts for their largely complementary distribution.

Taken together, we thus believe that our approach offers an improvement over previous (non-syntactic, hybrid and syntactic) analyses of SL agreement. We emphasize that we have only made use of modality-independent ingredients to account for the peculiarities of SL agreement in DGS. Below, we provide a list of these ingredients, and we also comment on how our recipe compares to previous accounts.

- **Ingredient I** (Section 4.2): An asymmetry in verb movement distinguishes RAVs from plain verbs. The distinction is lexically based and encoded by means of a movement diacritic on the former (cf. English lexical verbs vs. modals). Probably, as suggested by Meir (2002), class membership is (diachronically) motivated by phonological and semantic factors.
- **Ingredient II** (Section 4.2): The contextual allomorphy in the realization of *v* as PAM or zero is a consequence of Ingredient I (the asymmetry in verb movement): The lexical verb moves to *v* only in the case of agreement (regular and backwards) verbs, while in the case of plain verbs, it stays put, and consequently, *v* is realized as PAM. Comparable synthetic vs. analytic splits are attested in spoken languages (e.g. the Latin perfect).
- **Ingredient III** (Section 4.3): Variation in the order of Agree and Merge leads to different alignments; the asymmetry between RAVs and BAVs results from the use of the direct (i.e. “accusative”) alignment in RAVs and the reversed (i.e. “ergative”) alignment in BAVs. This pattern is reminiscent of split ergativity/agreement reversal in spoken languages; however, it is a lexical property of certain verbs. Recall that the same is true in Meir’s account, as she needs to guarantee that each verb combines with the appropriate DIR morpheme in (7).
- **Ingredient IV** (Section 4.3): An impoverishment rule optionally deletes the features of the subject on *v*/T; this rule accounts for the fact that subject markers can sometimes be omitted. In contrast, Meir et al. (2007) argue that subject marker omission is the result of a sort of modality-specific default rule, which treats the “body as subject”.
- **Ingredient V** (Section 4.4): An additional probe on *v*, which is not a full phi-probe (it only involves person but not number), leads to agreement by orientation. We thus offer a formalization of the observation made by Meir (2002) that agreement by orientation is syntactic, and we point out similarities to participle agreement in French.

The grammatical system provides these five ingredients in a way that they are available in both modalities. Still, the way these ingredients are combined, i.e. the recipe, appears to be specific for our analysis of agreement in DGS. We suggest that the following three properties of SLs favor this modality-specific recipe (we turn to general typological consequences of this recipe below).

First of all, the use of space to express topographic and grammatical relations is unique to SLs (Meier 2002b; 2012; Aronoff et al. 2005). Unlike spoken languages, sign languages make systematic use of the three-dimensional properties of the signing space to express various grammatical features such as agreement, plurality, telicity, topographic relations, discourse referents, specificity, or plurality of relations, among others (Wilbur 2003; Pfau & Steinbach 2006; Barberà 2015; Strickland et al. 2015; Pfau & Steinbach 2016; Steinbach & Onea 2016).

Second, the overt spatial realization of these features depends on the physical properties of space. Especially location and movement in space are two important aspects of agreement marking in SLs. Since both location and movement are phonological parameters in SLs at the same time, the lexical specification of these two parameters plays an important part in the expression of agreement. Consequently, plain verbs, which are lexically specified for these two phonological parameters, cannot express agreement by path movement or hand orientation. Interestingly, plain verbs may lose such a lexical specification and turn into agreement verbs, as is true, for instance, for the DGS verb TRUST. Hence, an idiosyncratic phonological specification blocking the expression of agreement can be abandoned for

the sake of agreement. As already mentioned in Section 3, we observe a general change towards “more” agreement in SLs.

Third, SL agreement may also have a spatial-thematic origin since it frequently expresses transfer relations. This transparent thematic basis seems to have paved the way for a semantic implementation of agreement in SLs as proposed by Meir (1998; 2002) and may have originally motivated the different verb classes. In a second step, the systematic overt realization of thematic agreement with RAVs may have triggered the grammaticalization of agreement features. Finally, in some SLs, the emergence of agreement auxiliaries seems to be the final step towards a fully grammaticalized syntactic agreement system as described for DGS in Section 4 above.

Let us finally turn to a typological consequence of the specific recipe for agreement in DGS. Since the ingredients of syntactic agreement are combined in a modality-specific way, we expect a bigger uniformity of agreement in the visual-gestural modality. At various points throughout this article, we have suggested that our analysis of agreement in DGS is also applicable to other SLs. The existing descriptions of the agreement systems of other SLs indeed show that many SLs use the same – or at least a very similar – agreement recipe as DGS does. Still, this should not be taken to imply that in the realm of agreement, all SLs behave in the same way. Let us briefly consider some of the attested variation.

First, there are SLs that do not employ agreement verbs at all. Sticking to our recipe metaphor, one could say that these SLs are frugal in this respect. Two rural SLs, namely Kata Kolok, used in a village in Bali (de Vos 2012; de Vos & Pfau 2015), and Al Sayyid Bedouin SL, used in a community in the Negev desert in Israel (Aronoff et al. 2008; Padden et al. 2010), are prominent examples. In both SLs, the direction of the path movement of verbal signs “did not reflect the transfer of an entity from source to goal” (Aronoff et al. 2008: 148). Instead, signers typically use an uninflected citation form of the verb and indicate the subject and object by means of pointing signs.<sup>43</sup>

Second, some SLs seem to be on the way to develop a grammatical agreement system, i.e. a system that loses its thematic basis and uses the modality-specific grammatical recipe described above. Senghas & Coppola (2001), for instance, describe an interesting change in the use of spatial modulations indicating shared reference in Nicaraguan SL. Spatially modulated verbs occurred significantly more frequently in the signing of early-exposed second cohort signers than in the signing of early-exposed first cohort signers (where early exposure means before the age of 6 years, 6 months). This implies that the grammaticalization of an agreement system, as described above, can also be observed in emerging SLs such as Nicaraguan SL.

A third source of variation is the presence or absence of agreement auxiliaries, which is related to ingredient II. Agreement auxiliaries are attested in many typologically different SLs (Steinbach & Pfau 2007; Sapountzaki 2012). However, some SLs such as ASL and BSL do not use agreement auxiliaries at all; thus, while they express agreement with regular and backwards agreement verbs, it seems that agreement is not manually expressed in the context of plain verbs. Note that the lack of agreement auxiliaries does not imply that SLs without agreement auxiliaries do not have syntactic agreement – after all, like DGS, both ASL and BSL use inflected agreement verbs. Moreover, it has been argued that ASL uses head tilt and eye gaze to realize subject and object agreement non-manually (Bahan 1996; Bahan et al. 2000). Following this line of argumentation, non-manual markers would be an alternative strategy to express agreement features with plain verbs, i.e. an alternative realization of *v* in (17b) making the development of (manual) agreement auxiliaries

<sup>43</sup> For Kata Kolok, it has been observed that the sign GIVE is the only verb that is occasionally modified in space, which is not unexpected given that this verb most concretely encodes the transfer semantics.

redundant in such non-manual agreement languages.<sup>44</sup> Our analysis therefore does not imply that all SLs should develop agreement auxiliaries; rather, it is straightforwardly compatible with alternative realizations of agreement in the context of plain verbs, such as non-manual marking. We leave for further research whether non-manual agreement marking is a typological alternative available in SLs to express syntactic agreement with plain verbs or whether SLs without (manual) agreement auxiliaries have developed a different agreement system.

## 6 Conclusion

In this paper, we have argued that agreement in DGS is consistently syntactic agreement – contra previous gestural and hybrid (thematic and syntactic) analyses (Meir 1998; 2002; Liddell 1995; 2003; Schembri et al. 2018). Furthermore, unlike previous syntactic approaches that have reinterpreted SL agreement as clitic doubling (Nevins 2011), we argue that the spatial modulation of verbs in SLs indeed represents canonical syntactic agreement. A central piece of evidence for our claim comes from agreement auxiliaries, which express agreement by path movement without having a corresponding thematic structure or gestural basis. Recall that the DGS agreement auxiliary PAM has been developed from the noun PERSON, which is a lexical noun (and not a gesture) without a thematic structure.

In our analysis, agreement by path movement results from Agree operations between object/subject and v/T, respectively. The distribution of the agreement auxiliary is related to differences in verb movement between the different verb classes. To accommodate backwards verbs, we suggested that they show ergative/reversed agreement. Agreement by orientation, finally, realizes an additional Agree relationship between v and the object. We thus have argued that SL agreement can be analyzed with the same basic ingredients that are also used for the analysis of spoken language agreement, that is, the proposed mechanisms are independently motivated and modality-independent. We take this to be a strong argument in favor of our approach. We argue that the underlying grammatical structures are basically modality-unspecific. Some specific features of SL agreement result from a special combination of independently established mechanisms. This special recipe is motivated by the gestural and spatial properties of SLs such as the thematic origin of agreement, the use of the three-dimensional signing space, and the simultaneous realization of grammatical features.

It remains as a task for future research to investigate whether all SLs can be subsumed under the syntactic account. It might well turn out that SLs which have not developed agreement auxiliaries or SLs which feature either no or a less grammaticalized system of argument marking on verbs require a different analysis.

## Abbreviations

SL = sign language, ASL = American Sign Language, BSL = British Sign Language, DGS = German Sign Language (*Deutsche Gebärdensprache*), ISL = Israeli Sign Language, Libras = Brazilian Sign Language (*Língua de Sinais Brasileira*), LSC = Catalan Sign Language (*Llengua de Signes Catalana*), LSE = Spanish Sign Language (*Lengua de Signos Española*), NGT = Sign Language of the Netherlands (*Nederlandse Gebarentaal*), ÖGS = Austrian Sign Language (*Österreichische Gebärdensprache*).

BAV = backward agreement verb, DIR = directional morpheme, iphi = interpretable (valued) feature bundle of the agreement controller, LCS = Lexical-Conceptual Structure, PAM = person agreement marker, PCC = Person Case Constraint, PF = Phonological Form, RAV = regular agreement verb, TSA = Thematic Structure Agreement, uD =

<sup>44</sup> But see Thompson et al. (2006), who provide empirical evidence that eye gaze is not systematically used to express object agreement with plain verbs in ASL (for a similar experiment on DGS, see Hosemann 2011).



uninterpretable structure building feature that introduces an argument,  $\text{uphi}$  = uninterpretable (unvalued) feature bundle of the agreement target that searches for valued counterparts on arguments.

## Acknowledgements

We are very grateful to three anonymous reviewers, who provided constructive critique that helped us to improve the paper. The usual disclaimers apply. Earlier versions of this research have been presented at FEAST 1 in Venice (June 2011), at DGfS 38 in Constance (February 2016), and at GLOW 40 in Leiden (April 2017). We are grateful to the respective audiences for helpful discussion and numerous suggestions, in particular to Carlo Cecchetto, Caterina Donati, Carlo Geraci, Irit Meir, Josep Quer, and Ronnie Wilbur. This research has been partially supported by the Dutch Science Foundation (NWO), grant #360-70-520 (Pfau); by the German Science Foundation (DFG), grant SA 2646/1-1 (Salzmann) and grant STE 958/8-1 (Steinbach); and by the European Union's Horizon 2020 research and innovation programme (SIGN-HUB), grant #693349 (Steinbach).

## Competing Interests

The authors have no competing interests to declare.

## References

- Adger, David. 2003. *Core syntax. A minimalist approach*. Oxford: Oxford University Press.
- Aissen, Judith. 1997. On the syntax of obviation. *Language* 73. 705–750. DOI: <https://doi.org/10.1353/lan.1997.0042>
- Aissen, Judith. 2003. Differential object marking: Iconicity vs. economy. *Natural Language and Linguistic Theory* 21. 435–483. DOI: <https://doi.org/10.1023/A:1024109008573>
- Aronoff, Mark, Irit Meir, Carol Padden & Wendy Sandler. 2008. The roots of linguistic organization in a new language. *Interaction Studies* 9(1). 133–153. DOI: <https://doi.org/10.1075/is.9.1.10aro>
- Aronoff, Mark, Irit Meir & Wendy Sandler. 2005. The paradox of sign language morphology. *Language* 81(2). 301–344. DOI: <https://doi.org/10.1353/lan.2005.0043>
- Arregi, Karlos & Andrew Nevins. 2012. *Morphotactics: Basque auxiliaries and the structure of spellout*. Dordrecht: Springer. DOI: <https://doi.org/10.1007/978-94-007-3889-8>
- Baerman, Matthew. 2007. Morphological reversals. *Journal of Linguistics* 43. 33–61. DOI: <https://doi.org/10.1017/S0022226706004440>
- Bahan, Benjamin. 1996. *Non-manual realization of agreement in ASL*. Boston, MA: Boston University dissertation.
- Bahan, Benjamin, Judy Kegl, Robert G. Lee, Dawn MacLaughlin & Carol Neidle. 2000. The licensing of null arguments in American Sign Language. *Linguistic Inquiry* 31(1). 1–27. DOI: <https://doi.org/10.1162/002438900554271>
- Baker, Mark C. 2008. *The syntax of agreement and concord*. Cambridge: Cambridge University Press. DOI: <https://doi.org/10.1017/CBO9780511619830>
- Barberà, Gemma. 2015. *The meaning of space in sign language. Reference, specificity and structure in Catalan Sign Language discourse*. Berlin: De Gruyter Mouton and Ishara Press. DOI: <https://doi.org/10.1515/9781614518815>
- Berendsen, Egon. 1986. *The phonology of cliticization*. Dordrecht: Foris. DOI: <https://doi.org/10.1515/9783111403144>
- Bobaljik, Jonathan. 2008. Where's Phi? Agreement as a post-syntactic operation. In David Adger, Daniel Harbour & Susana Béjar (eds.), *Phi theory: Phi features across interfaces and modules*, 295–328. Oxford: Oxford University Press.



- Bobaljik, Jonathan & Phil Branigan. 2006. Eccentric agreement and multiple case checking. In Alana Johns, Diane Massam & Juvenal Ndayiragije (eds.), *Ergativity: Emerging issues*, 47–77. Dordrecht: Springer.
- Bos, Heleen. 2017[1998]. An analysis of main verb agreement and auxiliary agreement in NGT within the theory of Conceptual Semantics (Jackendoff 1990). *Sign Language & Linguistics* 20(2). 228–252. DOI: <https://doi.org/10.1075/sll.00003.bos>
- Bošković, Željko. 2007. On the locality and motivation of move and agree: An even more minimal theory. *Linguistic Inquiry* 38. 589–644. DOI: <https://doi.org/10.1162/ling.2007.38.4.589>
- Brentari, Diane. 1988. Backwards verbs in ASL: Agreement re-opened. *Chicago Linguistic Society* 24(2). 16–27.
- Bross, Fabian. 2018. Differential object marking in German Sign Language: Animacy and definiteness as cross-linguistically stable cognitive concepts. *Paper presented at the VIII International Symposium on Intercultural, Cognitive and Social Pragmatics*, Sevilla.
- Capek, Cheryl M., Giordana Grossi, Aaron J. Newman, Susan L. McBurney, David Corina, Brigitte Röder & Helen J. Neville. 2009. Brain systems mediating semantic and syntactic processing in deaf native signers: Biological invariance and modality specificity. *PNAS* 106(21). 8784–8789. DOI: <https://doi.org/10.1073/pnas.0809609106>
- Chomsky, Noam. 2000. Minimalist inquiries: The framework. In Roger Martin, David Michaels & Juan Uriagereka (eds.), *Step by step. Essays on minimalist syntax in honor of Howard Lasnik*, 89–156. Cambridge, MA: MIT Press.
- Corbett, Greville G. 2006. *Agreement*. Cambridge: Cambridge University Press.
- Costello, Brendan D. N. 2015. *Language and modality: Effects of the use of space in the agreement system of lengua de signos española (Spanish Sign Language)*. Amsterdam: University of Amsterdam and University of the Basque Country dissertation.
- Cysouw, Michael. 2011. Very atypical agreement indeed. *Theoretical Linguistics* 37(3/4). 153–160. DOI: <https://doi.org/10.1515/thli.2011.011>
- Deal, Amy Rose. 2015. Ergativity. In Tibor Kiss & Artemis Alexiadou (eds.), *Syntax – theory and analysis. An international handbook* 1. 654–708. Berlin: Mouton de Gruyter.
- De Beuzeville, Louise, Trevor Johnston & Adam Schembri. 2009. The use of space with indicating verbs in Auslan: A corpus-based investigation. *Sign Language & Linguistics* 12(1). 53–82. DOI: <https://doi.org/10.1075/sll.12.1.03deb>
- de Quadros, Ronice M. 1999. *Phrase structure in Brazilian Sign Language*. Porto Alegre: Pontifícia Universidade Católica do Rio Grande do Sul dissertation.
- de Quadros, Ronice M. & Josep Quer. 2008. Back to (back)wards and moving on: On agreement, auxiliaries and verb classes in sign languages. In Ronice M. de Quadros (ed.), *Sign languages: Spinning and unraveling the past, present and future*, 530–551. Editora Arara Azul. Petrópolis/RJ. Brazil.
- de Quadros, Ronice M. & Josep Quer. 2011. The proper characterization of agreement in sign languages. Ms, Universidade Federal de Santa Catarina & ICREA-Universitat Pompeu Fabra.
- de Vos, Connie. 2012. *Sign-spatiality in Kata Kolok: How a village sign language in Bali inscribes its signing space*. Nijmegen: Radboud University Nijmegen dissertation.
- de Vos, Connie & Roland Pfau. 2015. Sign language typology: The contribution of rural sign languages. *Annual Review of Linguistics* 1. 265–288. DOI: <https://doi.org/10.1146/annurev-linguist-030514-124958>
- Dryer, Matthew S. 1986. Primary objects, secondary objects, and antitativity. *Language* 62. 808–845. DOI: <https://doi.org/10.2307/415173>

- Embick, David. 2000. Features, syntax, and categories in the Latin perfect. *Linguistic Inquiry* 31. 185–230. DOI: <https://doi.org/10.1162/002438900554343>
- Embick, David. 2015. *The morpheme. A theoretical introduction*. Boston/Berlin: De Gruyter Mouton. DOI: <https://doi.org/10.1515/9781501502569>
- Embick, David & Rolf Noyer. 2001. Movement operations after syntax. *Linguistic Inquiry* 32. 555–595. DOI: <https://doi.org/10.1162/002438901753373005>
- Fauconnier, Gilles. 1985. *Mental spaces*. Cambridge, MA: MIT Press.
- Fauconnier, Gilles. 1997. *Mappings in thought and language*. Cambridge: Cambridge University Press. DOI: <https://doi.org/10.1017/CBO9781139174220>
- Fenlon, Jordan, Adam Schembri & Kearsy Cormier. 2018. Modification of indicating verbs in British Sign Language: A corpus-based study. *Language* 94. 84–118. DOI: <https://doi.org/10.1353/lan.2018.0002>
- Fischer, Susan. 1975. Influences on word order change in American Sign Language. In Charles Li (ed.), *Word order and word order change*, 1–25. Austin, TX: University of Texas Press.
- Fischer, Susan. 1996. The role of agreement and auxiliaries in sign language. *Lingua* 98. 103–120. DOI: [https://doi.org/10.1016/0024-3841\(95\)00034-8](https://doi.org/10.1016/0024-3841(95)00034-8)
- Fischer, Susan & Bonnie Gough. 1978. Verbs in American Sign Language. *Sign Language Studies* 18. 17–48. DOI: <https://doi.org/10.1353/sls.1978.0014>
- Georgi, Doreen. 2013. A relativized probing approach to person encoding in local scenarios. *Linguistic Variation* 12. 153–210. DOI: <https://doi.org/10.1075/lv.12.2.02geo>
- Georgi, Doreen & Gereon Müller. 2010. Noun-phrase structure by reprojection. *Syntax* 13. 1–36. DOI: <https://doi.org/10.1111/j.1467-9612.2009.00132.x>
- Geraci, Carlo, Lara Mantovan, Mirko Santoro & Valentina Aristodemo. 2016. Is it going backwards? Not really! *Paper presented at Formal and Experimental Advances in Sign Language Theory (FEAST 7)*, Venice.
- Glück, Susanne & Roland Pfau. 1998. On classifying classification as a class of inflection in German Sign Language. In Tina Cambier-Langeveld, Aniko Lipták & Michael Redford (eds.), *Proceedings of ConSole* 6. 59–74. Leiden: SOLE.
- Gökgöz, Kadir. 2013. *The nature of object marking in American Sign Language*. West-Lafayette, IN: Purdue University dissertation.
- Göksel, Asli & Meltem Keleş. 2016. Observations on clausal complementation in Turkish Sign Language. In Roland Pfau, Markus Steinbach & Annika Herrmann (eds.), *A matter of complexity: Subordination in sign languages*, 65–94. Berlin: De Gruyter Mouton.
- Haider, Hubert. 2010. *The syntax of German*. Cambridge: Cambridge University Press. DOI: <https://doi.org/10.1017/CBO9780511845314>
- Halle, Morris & Alec Marantz. 1993. Distributed morphology and the pieces of inflection. In Kenneth Hale & Samuel J. Keyser (eds.), *The view from building 20. Essays in linguistics in honour of Sylvain Bromberger*, 111–176. Cambridge, MA: MIT Press.
- Hänel-Faulhaber, Barbara, Nils Skotara, Monique Kügow, Uta Salden, Davide Bottari & Brigitte Röder. 2014. ERP correlates of German Sign Language processing in deaf native signers. *BMC Neuroscience* 15(62). 1–11. DOI: <https://doi.org/10.1186/1471-2202-15-62>
- Haspelmath, Martin. 2004. Periphrasis. In Geert Booij, Christian Lehmann, Joachim Mugdan & Stavros Skopeteas (eds.), *Morphology. An international handbook on inflection and word-formation*, 654–664. Berlin: De Gruyter.
- Hilpert, Martin. 2008. The English comparative – language structure and language use. *English Language and Linguistics* 12. 395–417. DOI: <https://doi.org/10.1017/S1360674308002694>

- Holle, Henning, Christian Obermeier, Maren Schmidt-Kassow, Angela D. Friederici, Jamie Ward & Thomas C. Gunter. 2012. Gesture facilitates the syntactic analysis of speech. *Frontiers in Psychology* 3. 74. DOI: <https://doi.org/10.3389/fpsyg.2012.00074>
- Hosemann, Jana. 2011. Eye gaze and verb agreement in German Sign Language: A first glance. In Annika Herrmann & Markus Steinbach (eds.), *Nonmanuals in sign languages*, 76–93 [Special issue of *Sign Language & Linguistics* 14(1)].
- Hosemann, Jana, Annika Herrmann, Holger Sennhenn-Reulen, Matthias Schlesewsky & Markus Steinbach. 2018. Agreement or no agreement. ERP correlates of verb agreement violation in German Sign Language. *To appear in Language, Cognition and Neuroscience*.
- Jackendoff, Ray. 1990. *Semantic structures*. Cambridge, MA: MIT Press.
- Janis, Wynne D. 1995. A crosslinguistic perspective on ASL verb agreement. In Karen Emmorey & Judy Reilly (eds.), *Language, gesture, and space*, 195–223. Hillsdale, NJ: Erlbaum.
- Kalin, Laura. 2015. Morphological reversal in Amadiya as late agreement. In Pocholo Umbal & Kyeong-min Kim (eds.), *Proceedings of the Poster Session of the 33<sup>rd</sup> West Coast Conference on Formal Linguistics* (Simon Fraser University Working Papers 5), 66–75.
- Kalin, Laura. 2018. Licensing and differential object marking: The view from Neo-Aramaic. *Syntax* 21. 112–159. DOI: <https://doi.org/10.1111/synt.12153>
- Kalin, Laura & Coppe van Urk. 2015. Aspect splits without ergativity. *Natural Language and Linguistic Theory* 33. 659–702. DOI: <https://doi.org/10.1007/s11049-014-9262-8>
- Kayne, Richard S. 1994. *The antisymmetry of syntax*. Cambridge, MA: MIT Press.
- Keine, Stefan. 2010. *Case and agreement from Fringe to Core. A minimalist approach*. Berlin: De Gruyter. DOI: <https://doi.org/10.1515/9783110234404>
- Keller, Jörg. 1998. *Aspekte der Raumnutzung in der Deutschen Gebärdensprache*. Hamburg: Signum.
- Kendon, Adam. 2004. *Gesture: Visible action as utterance*. Cambridge: Cambridge University Press. DOI: <https://doi.org/10.1017/CBO9780511807572>
- Kita, Sotaro (ed.) 2003. *Pointing: Where language, culture, and cognition meet*. Mahwah, NJ: Lawrence Erlbaum.
- Kita, Sotaro & Aslı Özyürek. 2003. What does cross-linguistic variation in semantic coordination of speech and gesture reveal? Evidence for an interface representation of spatial thinking and speaking. *Journal of Memory and Language* 48. 16–32. DOI: [https://doi.org/10.1016/S0749-596X\(02\)00505-3](https://doi.org/10.1016/S0749-596X(02)00505-3)
- Klavans, Judith L. 1995. *On clitics and cliticization: The interaction of morphology, phonology, and syntax*. New York: Garland Publishing.
- Krebs, Julia, Ronnie B. Wilbur & Dietmar Roehm. 2017. Two agreement markers in Austrian Sign Language (ÖGS). *Sign Language & Linguistics* 20(1). 27–54. DOI: <https://doi.org/10.1075/sll.20.1.02kre>
- Lehmann, Christian. 1982. On the function of agreement. In Michael Barlow & Charles A. Ferguson (eds.), *Agreement in natural language: Approaches, theories, descriptions*, 55–65. Stanford, CA: CSLI Publications.
- Liddell, Scott K. 1995. Real, surrogate, and token space: Grammatical consequences in ASL. In Karen Emmorey & Judy Reilly (eds.), *Language, gesture, and space*, 19–41. Hillsdale, NJ: Lawrence Erlbaum.
- Liddell, Scott K. 2003. *Grammar, gesture, and meaning in American Sign Language*. Cambridge: Cambridge University Press. DOI: <https://doi.org/10.1017/CBO9780511615054>

- Liddell, Scott K. 2011. Agreement disagreements. *Theoretical Linguistics* 37(3/4). 161–172. DOI: <https://doi.org/10.1515/thli.2011.012>
- Lillo-Martin, Diane. 1986. Two kinds of null arguments in American Sign Language. *Natural Language and Linguistic Theory* 4. 415–444. DOI: <https://doi.org/10.1007/BF00134469>
- Lillo-Martin, Diane & Edward S. Klima. 1990. Pointing out differences: ASL pronouns in syntactic theory. In Susan D. Fischer & Patricia Siple (eds.), *Theoretical issues in sign language research. Vol. 1: Linguistics*, 191–210. Chicago, IL: University of Chicago Press.
- Lillo-Martin, Diane & Richard P. Meier. 2011. On the linguistic status of ‘agreement’ in sign languages. *Theoretical Linguistics* 37(3/4). 95–141. DOI: <https://doi.org/10.1515/thli.2011.009>
- Lourenço, Guilherme. 2015. Regular and backward agreement verbs in Libras: Outlining a syntactic derivation. *Paper presented at Formal and Experimental Advances in Sign Language Theory (FEAST 4)*, Barcelona.
- Macht, Claudia. 2016. *Distribution von PAM in der Deutschen Gebärdensprache. Eine korpusbasierte Untersuchung*. Hamburg: University of Hamburg MA thesis.
- Macht, Claudia & Markus Steinbach. In press. Regionalsprachliche Merkmale in der Deutschen Gebärdensprache. In Joachim Herrgen & Jürgen Erich Schmidt (eds.), *Sprache und Raum. Ein internationales Handbuch der Sprachvariation*. Berlin: De Gruyter Mouton.
- Maier, Emar. 2017. The pragmatics of attraction: Explaining unquotation in direct and free indirect discourse. In Paul Saka & Michael Johnson (eds.), *The semantics and pragmatics of quotation*, 259–280. Berlin: Springer.
- Marlett, Stephen A. 1986. Syntactic levels and multiattachment in Sierra Popoluca. *International Journal of American Linguistics* 52. 359–387. DOI: <https://doi.org/10.1086/466029>
- Mathur, Gaurav. 2000. *Verb agreement as alignment in signed languages*. Cambridge, MA: MIT dissertation.
- Mathur, Gaurav & Christian Rathmann. 2010. Verb agreement in sign language morphology. In Diane Brentari (ed.), *Sign languages* (Cambridge Language Surveys), 173–224. Cambridge: Cambridge University Press.
- Mathur, Gaurav & Christian Rathmann. 2012. Verb agreement. In Roland Pfau, Markus Steinbach & Bencie Woll (eds.), *Sign language. An international handbook*, 136–157. Berlin: De Gruyter Mouton.
- Matushansky, Ora. 2006. Head movement in linguistic theory. *Linguistic Inquiry* 37. 69–109. DOI: <https://doi.org/10.1162/002438906775321184>
- McKee, Rachel, Adam Schembri, David McKee & Trevor Johnston. 2011. Variable ‘subject’ presence in Australian Sign Language and New Zealand Sign Language. *Language Variation and Change* 23. 375–398. DOI: <https://doi.org/10.1017/S0954394511000123>
- Meier, Richard P. 1982. *Icons, analogues, and morphemes: The acquisition of verb agreement in ASL*. San Diego, CA: University of California, San Diego dissertation.
- Meier, Richard P. 1990. Person deixis in American Sign Language. In Susan D. Fischer & Patricia Siple (eds.), *Theoretical issues in sign language research. Vol. 1: Linguistics*, 175–190. Chicago, IL: University of Chicago Press.
- Meier, Richard P. 2002a. The acquisition of verb agreement: Pointing out arguments for the linguistic status of agreement in signed languages. In Gary Morgan & Bencie Woll (eds.), *Directions in sign language acquisition*, 115–141. Amsterdam: John Benjamins.
- Meier, Richard P. 2002b. Why different, why the same? Explaining effects and non-effects of modality upon linguistic structure in sign and speech. In Richard P. Meier, Kearsy Cormier & David Quinto-Pozos (eds.), *Modality and structure in signed and spoken languages*, 1–25. Cambridge: Cambridge University Press.



- Meier, Richard P. 2012. Language and modality. In Roland Pfau, Markus Steinbach & Bencie Woll (eds.), *Sign language. An international handbook*, 574–601. Berlin: De Gruyter Mouton.
- Meir, Irit. 1998. *Thematic structure and verb agreement in Israeli Sign Language*. Jerusalem: Hebrew University of Jerusalem dissertation.
- Meir, Irit. 2002. A cross-modality perspective on verb agreement. *Natural Language and Linguistic Theory* 20. 413–450. DOI: <https://doi.org/10.1023/A:1015041113514>
- Meir, Irit. 2012. The evolution of verb classes and verb agreement in sign languages. *Theoretical Linguistics* 38(1/2). 145–152. DOI: <https://doi.org/10.1515/tl-2012-0008>
- Meir, Irit. 2016. Grammaticalization is not the full story: A non-grammaticalization account of the emergence of sign language agreement morphemes. *MMM10 Online Proceedings*. 112–124.
- Meir, Irit, Carol A. Padden, Mark Aronoff & Wendy Sandler. 2007. Body as subject. *Journal of Linguistics* 43. 531–563. DOI: <https://doi.org/10.1017/S0022226707004768>
- Moravcsik, Edith A. 1978. Agreement. In Joseph H. Greenberg, Charles A. Ferguson & Edith A. Moravcsik (eds.), *Universals of human language. Vol. IV: Syntax*, 331–374. Stanford, CA: Stanford University Press.
- Morgan, Gary, Isabelle Barrière & Bencie Woll. 2006. The influence of typology and modality on the acquisition of verb agreement morphology in British Sign Language. *First Language* 26. 19–43. DOI: <https://doi.org/10.1177/0142723706060739>
- Morimoto, Yukiko. 2008. From topic to subject marking: Implications for a typology of subject marking. In Helen de Hoop & Peter de Swart (eds.), *Differential subject marking*, 199–221. Heidelberg: Springer.
- Müller, Gereon. 2009. Ergativity, accusativity, and the order of Merge and Agree. In Kleanthes K. Grohmann (ed.), *Explorations of phase theory. Features and arguments*, 269–308. Berlin: Mouton de Gruyter.
- Murmann, Christina, Peter Indefrey, Thomas Weskott & Markus Steinbach. 2013. Why FORGET needs help but HELP does not. An experimental study on the influence of animacy/agreement on the distribution of PAM. *Poster presented at Theoretical Issues in Sign Language Research (TISLR 11)*, London.
- Nevins, Andrew. 2011. Prospects and challenges for a clitic analysis of (A)SL agreement. *Theoretical Linguistics* 37. 173–187. DOI: <https://doi.org/10.1515/thli.2011.013>
- Padden, Carol. 1983. *Interaction of morphology and syntax in American Sign Language*. San Diego, CA: University of California, San Diego dissertation [Published 1988 by Garland Outstanding Dissertations in Linguistics, New York].
- Padden, Carol, Irit Meir, Mark Aronoff & Wendy Sandler. 2010. The grammar of space in two new sign languages. In Diane Brentari (ed.), *Sign languages (Cambridge Language Surveys)*, 570–592. Cambridge: Cambridge University Press
- Pavlič, Matic. 2016. *The word order parameter in Slovenian Sign Language: Transitive, ditransitive, classifier and locative constructions*. Venice: Università Ca'Foscari, Venice dissertation.
- Perniss, Pamela, Roland Pfau & Markus Steinbach. 2007. Can't you see the difference? Sources of variation in sign language structure. In Pamela Perniss, Roland Pfau & Markus Steinbach (eds.), *Visible variation: Comparative studies on sign language structure*, 1–34. Berlin: Mouton de Gruyter.
- Pfau, Roland. 2002. Applying morphosyntactic and phonological readjustment rules in natural language negation. In Richard P. Meier, Kearsy Cormier & David Quinto-Pozos (eds.), *Modality and structure in signed and spoken languages*, 263–295. Cambridge: Cambridge University Press.



- Pfau, Roland. 2016. A featural approach to sign language negation. In Pierre Larrivé & Chungmin Lee (eds.), *Negation and polarity. Experimental perspectives*, 45–74. Dordrecht: Springer.
- Pfau, Roland & Markus Steinbach. 2006. Pluralization in sign and in speech: A cross-modal typological study. *Linguistic Typology* 10. 135–182. DOI: <https://doi.org/10.1515/LINGTY.2006.006>
- Pfau, Roland & Markus Steinbach. 2011. Grammaticalization in sign languages. In Bernd Heine & Heiko Narrog (eds.), *Handbook of Grammaticalization*, 681–693. Oxford: Oxford University Press.
- Pfau, Roland & Markus Steinbach. 2013. PERSON climbing up a tree (and other adventures in sign language grammaticalization). *Sign Language & Linguistics* 16. 189–220. DOI: <https://doi.org/10.1075/sll.16.2.04pfa>
- Pfau, Roland & Markus Steinbach. 2016. Modality and meaning. Plurality of relations in German Sign Language. *Lingua* 170. 69–91. DOI: <https://doi.org/10.1016/j.lingua.2015.11.002>
- Preminger, Omer. 2011. *Agreement as a fallible operation*. Cambridge, MA: MIT dissertation.
- Quer, Josep. 2011. When agreeing to disagree is not enough: Further arguments for the linguistic status of sign language agreement. *Theoretical Linguistics* 37(3/4). 189–196. DOI: <https://doi.org/10.1515/thli.2011.014>
- Quer, Josep. 2017. The right place for locative agreement in sign languages. *Paper presented at Chicago Linguistic Society 53*. Chicago, IL.
- Rathmann, Christian. 2000. *The optionality of agreement phrase: Evidence from signed languages*. Austin, TX: University of Texas at Austin MA Thesis.
- Rathmann, Christian. 2003. The optionality of agreement phrase: Evidence from German Sign Language (DGS). In William E. Griffin (ed.), *The role of agreement in natural language: TLS 5 Proceedings* (Texas Linguistics Forum 53), 181–192. Austin: Texas Linguistics Forum.
- Rathmann, Christian & Gaurav Mathur. 2002. Is verb agreement the same crossmodally? In Richard P. Meier, Kearsy Cormier & David Quinto-Pozos (eds.), *Modality and structure in signed and spoken languages*, 370–404. Cambridge: Cambridge University Press.
- Rathmann, Christian & Gaurav Mathur. 2005. Unexpressed features of verb agreement in signed languages. In Geert Booij, Emiliano Guevara, Angela Ralli, Salvatore Sgroi & Sergio Scalise (eds.), *Morphology and Linguistic Typology. On-line Proceedings of the 4<sup>th</sup> Mediterranean Morphology Meeting (MMM4)*, 235–250. Bologna: Università degli Studi di Bologna.
- Rathmann, Christian & Gaurav Mathur. 2011. A featural approach to verb agreement in signed languages. *Theoretical Linguistics* 37(3/4). 187–208. DOI: <https://doi.org/10.1515/thli.2011.015>
- Sandler, Wendy. 1999. The medium and the message: Prosodic interpretation of linguistic content in Israeli Sign Language. *Sign Language & Linguistics* 2(2). 187–215. DOI: <https://doi.org/10.1075/sll.2.2.04san>
- Sapountzaki, Galini. 2012. Agreement auxiliaries. In Roland Pfau, Markus Steinbach & Bencie Woll (eds.), *Sign language. An international handbook*, 204–227. Berlin: De Gruyter Mouton.
- Schembri, Adam, Jordan Fenlon, & Kearsy Cormier. 2018. Indicating verbs as typologically unique constructions: Reconsidering verb ‘agreement’ in sign languages. *Glossa* 3(1). 89. DOI: <https://doi.org/10.5334/gjgl.468>

- Schlenker, Philippe. 2011. Iconic agreement. *Theoretical Linguistics* 37(3/4). 223–234. DOI: <https://doi.org/10.1515/thli.2011.017>
- Schlenker, Philippe. To appear-a. Visible meaning: Sign language and the foundations of meaning. To appear in *Theoretical Linguistics*.
- Schlenker, Philippe. To appear-b. Gestural semantics. To appear in *Natural Language and Linguistic Theory*.
- Schuit, Joke. 2013. *Typological aspects of Inuit Sign Language*. Amsterdam: University of Amsterdam dissertation.
- Senghas, Ann & Marie Coppola. 2001. Children creating language: How Nicaraguan Sign Language acquired a spatial grammar. *Psychological Science* 12(4). 323–328. DOI: <https://doi.org/10.1111/1467-9280.00359>
- Siewierska, Anna. 2013. Verbal person marking. In Matthew S. Dryer & Martin Haspelmath (eds.), *The world atlas of language structures online*, chapter 102. Leipzig: Max-Planck-Institut für evolutionäre Anthropologie (<http://wals.info/chapter/102>).
- Steinbach, Markus. 2011. What do agreement auxiliaries reveal about the grammar of sign language agreement? *Theoretical Linguistics* 37(3/4). 209–221. DOI: <https://doi.org/10.1515/thli.2011.016>
- Steinbach, Markus & Edgar Onea. 2016. A DRT analysis of discourse referents and anaphora resolution in sign language. *Journal of Semantics* 33(3). 409–448. DOI: <https://doi.org/10.1093/jos/ffv002>
- Steinbach, Markus & Roland Pfau. 2007. Grammaticalization of auxiliaries in sign languages. In Pamela Perniss, Roland Pfau & Markus Steinbach (eds.), *Visible variation. Comparative studies on sign language structure*, 303–339. Berlin: Mouton de Gruyter.
- Strickland, Brent, Carlo Geraci, Emmanuel Chemla, Philippe Schlenker, Meltem Kelepir & Roland Pfau. 2015. Event representations constrain the structure of language: Sign language as a window into universally accessible linguistic biases. *Proceedings of the National Academy of Sciences (PNAS)* 112(19). 5968–5973. DOI: <https://doi.org/10.1073/pnas.1423080112>
- Talmy, Leonard. 2000. *Toward a cognitive semantics*. Cambridge, MA: MIT Press.
- Thompson, Robin, Karen Emmorey & Robert Kluender. 2006. The relationship between eye gaze and verb agreement in American Sign Language: An eye-tracking study. *Natural Language and Linguistic Theory* 24. 571–604. DOI: <https://doi.org/10.1007/s11049-005-1829-y>
- Wienholz, Anne, Derya Nuhbalaoglu, Nivedita Mani, Annika Herrmann, Edgar Onea & Markus Steinbach. Submitted. Pointing to the right side? An ERP study on anaphora resolution in German Sign Language. *PLOS ONE*. DOI: <https://doi.org/10.1371/journal.pone.0204223>
- Wilbur, Ronnie B. 1999. Metrical structure, morphological gaps, and possible grammaticalization in ASL. *Sign Language & Linguistics* 2(2). 217–244. DOI: <https://doi.org/10.1075/sll.2.2.05wil>
- Wilbur, Ronnie B. 2003. Representation of telicity in ASL. *Chicago Linguistic Society* 39(1). 354–368.
- Wilbur, Ronnie B. 2008. Complex predicates involving events, time and aspect: Is this why sign languages look so similar? In Josep Quer (ed.), *Signs of the time. Selected papers from TISLR 2004*, 217–250. Seedorf: Signum.
- Wilbur, Ronnie B. 2010. The semantics-phonology interface. In Diane Brentari (ed.), *Sign languages* (Cambridge Language Surveys), 355–380. Cambridge: Cambridge University Press.

- Wilbur, Ronnie B. 2013. The point of agreement: Changing how we think about sign language, gesture, and agreement. *Sign Language & Linguistics* 16(2). 221–258. DOI: <https://doi.org/10.1075/sll.16.2.05wil>
- Zeshan, Ulrike. 2008. Roots, leaves, and branches – the typology of sign languages. In Ronice M. de Quadros (ed.), *Sign languages: Spinning and unraveling the past, present and future*, 671–695. Petrópolis: Ed. Arara Azul.

**How to cite this article:** Pfau, Roland, Martin Salzmann and Markus Steinbach. 2018. The syntax of sign language agreement: Common ingredients, but unusual recipe. *Glossa: a journal of general linguistics* 3(1): 107.1–46, DOI: <https://doi.org/10.5334/gjgl.511>

**Submitted:** 27 August 2017    **Accepted:** 24 July 2018    **Published:** 09 October 2018

**Copyright:** © 2018 The Author(s). This is an open-access article distributed under the terms of the Creative Commons Attribution 4.0 International License (CC-BY 4.0), which permits unrestricted use, distribution, and reproduction in any medium, provided the original author and source are credited. See <http://creativecommons.org/licenses/by/4.0/>.



*Glossa: a journal of general linguistics* is a peer-reviewed open access journal published by Ubiquity Press.

OPEN ACCESS The Open Access logo, which is a stylized circular icon containing a person-like figure.